

WITH THIS ISSUE: STATION GUIDE SUPPLEMENT

# The Wireless World

MONTHLY ONE SHILLING

*COVERING EVERY WIRELESS INTEREST*

APRIL, 1940

*In The Wireless World, April 1940* **The Wireless World**  
**ALL-WAVE STATION GUIDE**

Principal Long- and Medium-wave European Broadcasting Stations in Order of Frequency

Station	to k.	Meters	kW.	Notes	Meters	kW.
Istanbul (Turkey)	162	1873.5	5	Bucharest (Romania)	823	364.5
Riga (Latvian)	153	1961	7	Kjer (No. 2) (U.S.S.R.)	832	380.8
Hilversum (No. 1) (Holland)	180	1675	130	Stavanger (Norway)	832	390.6
Radio Romania (Romania)	170	1875	150	Berlin (Germany)	841	368.7
Lahli (Finland)	186	1607	500	Sofia (Bulgaria)	850	352.9
Moscow (No. 1) (U.S.S.R.)	172	1744	80	Valencia (Spain)	850	349.2
Paris (Radio Paris) (France)	182	1648	120	Sinderepol (U.S.S.R.)	859	346.2
Ankara (Turkey)	182	1639	20	Strasbourg (France)	859	345.8
Trkutek (U.S.S.R.)	182	1600	60	Poznan (Poland)	859	342.1
Deutschlandsender (Germany)	182	1600	150	London Regional (Brookmans Park)	877	338.8
National (Droitwich)	191	1571	35		886	335.2
Minsk (U.S.S.R.)	200	1509	103			
Reykjavik (Iceland)	208	1442	150			
Moisla (Sweden)	208	1442	100			
Norouiblak (U.S.S.R.)	216	1379	120			
Warsaw (No. 1) (U.S.S.R.)	217.5	1339	1			
Luxemburg	224	1293	1			
Moscow (No. 2) (U.S.S.R.)	232	1250	1			
Kalundborg (Denmark)	232	1250	1			
Kiev (No. 1) (U.S.S.R.)	232	1250	1			
Tashkent (U.S.S.R.)	240	1209.6	1			
Bergen (Norway)	248	1170	1			
Oslo (Norway)	250.4	1153.8	1			
Aalesund (No. 1) (U.S.S.R.)	250	1153.8	1			
	260	1115.8	1			
	260	1107	1			
	271	1084	1			
	282	1080	10			
	283	882.3	10			
	310	864.6	10			
	317	864.6	10			
	317	857.1	18			
	350	834.5	15-30			
	350	765	10			
	350	765	20			
	350	765	20			

## A NEW OUTPUT VALVE

for D.C./A.C. Sets

# OSRAM

## VALVE

### TYPE KT35



#### CHARACTERISTICS

Heater current 0.3 (0.6)  
 Heater voltage 26.0 (13.0)  
 Anode voltage 200 max.  
 Screen voltage 200 max.  
 Anode dissipation 10 watts max.  
 Mutual conductance 10 mA/volt  
     at  $E_A$  175  
      $E_S$  175  
      $I_A$  57 mA  
 Power output 4.5 watts approx.  
 "International" Octal base.

Price each 10/6

The OSRAM KT35 is a Power Tetrode for the output stage of receivers and amplifiers in which the valve heaters are wired in series at a current of 0.3 amp.

The following are features of type KT35:

1. Designed to give optimum performance in Power with range of mains voltages from 200 to 250 volts.
2. Large undistorted Power output under working conditions — up to  $4\frac{1}{2}$  watts per valve at 175 actual anode and screen volts.
3. High sensitivity—Mutual conductance 10 mA/volt.
4. Suitable also for use in "midget" receivers for high and low voltage mains—output 1 watt down to 90 volts, or 2.4 watts at 125 volts H.T.
5. Fitted with centre-tapped heater so that a "12 volt" battery L.T. supply may be used if required.
6. "International" Octal base.

*Type KT.35 may be supplied and purchased without necessity for a special G.P.O. permit.*

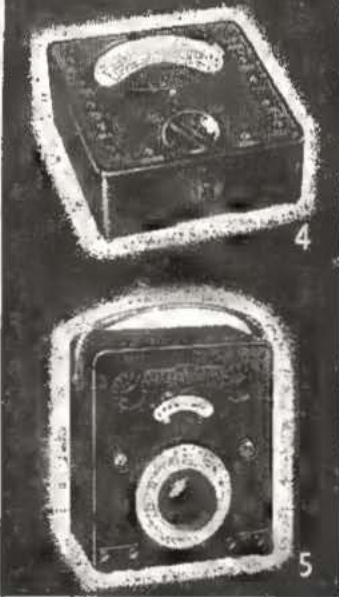

# 'AVO'

**ELECTRICAL  
MEASURING  
INSTRUMENTS**

BRITISH MADE

REGD. TRADE MARK

In every sphere of electrical test work ... in the laboratory, the workshop, the service engineer's bench or in the serious experimenter's den ... the word "AVO" is synonymous with instruments of precision.



The "AVO" range embraces instruments for every essential electrical test. By reason of their reliability and maintained accuracy, even under the most searching of workshop conditions, they are frequently used as a standard by which other Instruments are judged.

Write for fully descriptive literature dealing with any instrument in which you are interested, and for current prices.

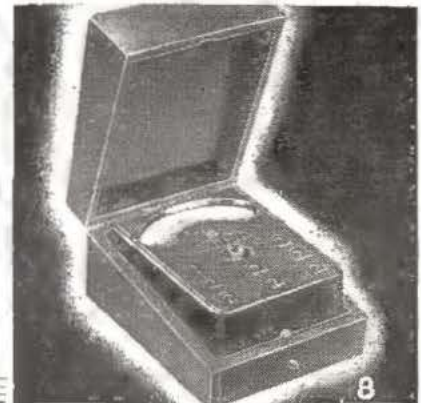

1. 46-range Model 7 Universal AvoMeter.
2. 40-range Model 40 Universal AvoMeter.
3. "Avo" Valve Tester.
4. Universal AvoMinor.
5. "Avo" Test Bridge.
6. "Avo" Capacity Meter.
7. All-Wave "Avo" Oscillator.
8. D.C. AvoMinor.

*Other "Avo" Instruments:*

- 22-range D.C. AvoMeter.
- High Resistance AvoMinor.
- "Avo" Low Resistance Ohmmeter.
- The AvoDapter.
- 9-pin AvoCoupler.

## PRECISION METERS

*that Master every Testing Problem*

*For Details write to: 37, Victoria Street*

**THE AUTOMATIC COIL WINDER & ELECTRICAL EQUIPMENT CO., LTD.,**  
Winder House, Douglas St., London, S.W.1.

Telephone: Victoria 3404/7

# McCLURE FEEDER UNITS

A sixth sense undoubtedly inspired us when we decided to put these units on the market. The British public, always ready to appreciate a good thing when it sees one, has taken our Feeders into its homes and heart, and our resulting Homeric labours are encouraged by the continued demand for them.

We thank our customers most heartily for their response, and wish them many hours of good listening and freedom from service troubles. We know they will have both whilst using our units.

- Model ACF3.** 3-band unit for AC operation with 4-volt valves. Coverage 18-30 m., 200-550 m., 750-2,000 m. R.F. stage on all bands. Complete with valves. Price £8 8 0
- Model UF3.** As above, but with 6.3 v., 2 amp. E type valves. Price £8 8 0
- Model ACF4.** 4-band units (as illustrated), similar in all respects to the above, but with coverage 121-35 m., 30-80 m., 200-550 m., 750-2,000 m. Price £8 18 6
- Model ACF5.** 5-band units, as above, but including in addition the "Traveler" band (75-200 m.). Price £9 9 0

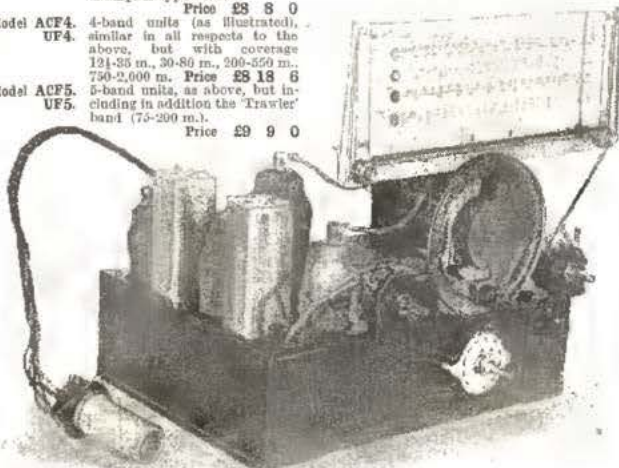

All models with E type valves can be wired either with heaters in series for AC/DC use, or in parallel for AC only.

RECOMMENDED BY "THE WIRELESS WORLD"

Demonstrations by appointment from 10 a.m. to 7 p.m. daily at our works.

Send for further particulars to—

JOHN McCLURE, LTD., ERSKINE ROAD, LONDON, N.W.3.

PR1 5435-6

# RADIOMART

G S N I ( B H A M ) L T D .

THE SHORT-WAVE SPECIALISTS

WE CARRY LARGE STOCKS OF ALL TYPES OF SHORT - WAVE AND COMMUNICATION EQUIPMENT, INCLUDING AMERICAN VALVES.

RADIOMART SPECIAL OFFERS! Fully shrouded Transformers by America's largest manufacturer. While they last, all 230 v. 50 cy.

T.850 Y—350/350 v. 150 m/A. 4 v. 6 a., 4 v. 2.5 a.	15-
T.19610—350/350 v. 150 m/A. 2.5 v. 6 a., 2.5 v. 2 a., 5 v. 3 a.	12/6
T.7236—375/375 v. 120 m/A. 6.3 v. 4 a., 5 v. 3 a.	10/6
T.3025—320/320 v. 80 m/A. 2.5 v. 6 a., 5 v. 3 a.	7/6
T.404919—19 v. 4 a., primary tapped 110-250 v.	8/6
W.379Y—440/440 v. 200 m/A. 6.3 v. 3 a. CT., 5 v. 3 a.	25-
W.308Y—550/550 v. 200 m/A. 6.3 v. 3 a. CT., 5 v. 3 a.	25-
T.1113AB—230 to 110 v. 500 watt auto transformer	29/6
T.2311A—230 v. to 110 v. 100 watt auto transformer	12/6

The following chokes are intercleaved and impregnated.

T7907—250 m/A., 135 ohms, 20-8 Hy., cadmium shrouded	12/6
T7907A—150 m/A., 250 ohms, 30-12 Hy., cadmium shrouded	12/6
100 m/A., 20 Hy., 500 ohms, unshrouded	4/11
60 m/A., 15 Hy., 250 ohms	1/11

FERRANTI Meters at less than half price. 3 1/2 in. Moving Coil, projecting 25, 50, 100 m.A. 16/6; Ditto, flush models, 17/6. Flush 0-1 m.A., 20/- All boxed, as new.

COSOR 8 in. M.C. Speakers, permanent magnet 14/6. 2,000 or 2,500-ohms energised, 8/6.

MOVING COIL SPEAKERS. Roda, Magnavox, etc. 8 in. cone; 1,200, 2,000, 2,500, 3,500 ohms, 8/6. 10 in. cone; 400, 800, 1,650, 2,000, 2,500 ohms, 12/6. Magna 10 in., 1,650, 2,000 ohms, 17/6. M.C. Speaker Transformers, Power, Pentode or Push-Pull, 1/11.

GANG CONDENSERS with Airplane Dial, 8 and 80-1. Cost 35/-. Few only. 4/11. Utility Microdials. List 7/6. Our Price, 3/9. Ideal for Short Waves.

PUSHBACK Wire, 6 yds., 6d.; heavy, 9d. Resin-cored Solder, 6ft., 6d.; Smeared Flux, single, 6d. yd.; twin, 9d. yd. Assorted Solder Tags, 6d. packet. Humdimmers, 6d. each. Centralab pots, all sizes, 1/9; switched, 2/3; tubular fuses, 2d. Milliammeters, 25 m/A. upwards, 6/9.

VALVES: Reliable replacements for all types, British and American, showing saving of over 50 per cent.

OUR NEW 66-PAGE MANUAL, packed full of valuable information. Metro-Kilocycle Charts, Shortwave Stations, Times of News Bulletins, Shortwave Receivers, constructional articles, etc. 7 1/2d. post free.

THE NEW RAYMART CATALOGUE shows dozens of New Shortwave Components and is yours for 1 1/2d. post free.

TRADE ENQUIRIES solicited for all types of communication equipment receivers, etc.

**RADIOMART 44, HOLLOWAY HEAD, BIRMINGHAM**

G S N I ( B i r m i n g h a m ) L t d .

# M-R SUPPLIES

again "on the map" with some timely bargains in first-class electrical apparatus. Order now with complete confidence of satisfaction.

**TIME SWITCHES** for automatic switching on and off radio, domestic appliances, lights (for black-out), etc. Very neat and compact job, approx. 5 in. square, finished in white enamel. Fitted reliable spring movement, breaking capacity up to 8 amps. Supplied with bracket for shelf, table or wall mounting. These were imported from America to sell at 42/-. We offer a limited supply at only 27/6 each.

**ELECTRO-MAGNETIC RELAYS** (ex-G.P.O.), coil resistance, 2,000 ohms. Change-over or make-and-break switch with platinum or tungsten contacts. All perfect, tested. With single bank of switches, 2/11; with 2 banks, 3/9; with 3 banks (multi-duty), 4/11. Also same switching duties, following resistance coils, 150, 500, 1,000 and 5,000 ohms, same prices.

**RADIO INTERFERENCE SUPPRESSORS**, definitely cut out all interference introduced through house mains. Thousands now in use. Twin waveform wound H.F. chokes and .1 plus .1 mf. condenser, with diagram. Post Office specification. 3/6.

**MINIATURE P.M. MOVING COIL UNITS**, only 5 in. dia., 15 ohms coil. Perfect m/coil makes as they are. Ideal for small extension speakers and for intercommunication. Very popular offer, 11/6.

**MINIATURE NICKEL ALLOY TRANSFORMERS**, for m/coil or carbon mike. Suitable for above units, 2/11. Also G.E.C. MICROPHONE TRANSFORMERS, fully shielded, 4 in. x 4 in. x 2 1/2 in., with plug type terminals, for m/coil or carbon mikes, 7/6.

**SHAFTSBURY AMPLIFIERS** (Brand new), LAST SIX of the £15/10/- model, A.C./D.C. 200/250 v. Output 6 watts. Complete equipments with Reisz type microphone, floor stand, speaker, all leads, etc., ready for use, £9/10/- (carriage 4/- extra). Also very latest high-fidelity 10-watt model, complete as above—the ideal portable equipment at bargain price, £14/10/- (carriage 4/- extra). Also other Shaftsbury, G.E.C. and Gramplan models. Get a good amplifier from us and save a lot of money and trouble.

**MULTI-RATIO OUTPUT TRANSFORMERS**, Gramplan all-matching model for all speakers. Tapped primary and secondary giving eight popular ratios for all outputs, 5/6. Also final supply at the price, "WIRELESS WORLD" UNIVERSAL MODEL, 11 ratios from 12/1 to 75/1 with C.T. for push-pull. Finest output transformer designed. Response 25,10,000 c/s. Weight 7 1/2 lb. (Usually 45/- at least). Last supply at 28/6 each.

**ROTHERMEL PIEZO-CRYSTAL PICK-UP HEADS**, de Luxe model. Supplied with adaptor enabling the head to be used on either tone-arm or tracking arm. Supplies of crystal pick-ups are now difficult, and this is a real opportunity. Magnificent performance, 18/6 complete. Also the new ROTHERMEL JUNIOR PIEZO-CRYSTAL PICK-UP, complete with tracking arm and rest at 19/6.

**SLIDING REOSTATS**, fully enclosed, 7 in. long with smooth action. For chargers, motors, lights, etc. 400 ohms .75 amp., or 600 ohms .5 amp., either 9/6. Also same style, 10 ohms 3 amp., 12/6.

**PHOTO-ELECTRIC CELLS**. These professional Cetron C.E.1 cells cannot be repeated under 93/-, 100 microamps per lumen, only 1 1/2 in. dia., 3 1/2 in. long. This model is standard to many talkie machines. Last few at 39/6.

**ROTARY CONVERTERS**, Westinghouse, in fine condition and guaranteed elec. and mechanical perfect. Input 110/120 v. D.C., output 110 v. A.C., 15.5 amps (1,500 watts). Very efficient machines. (List 23/-) We offer eight only at £8/10/- each. Also three only E.D.C. Input 230/250 v. D.C., output 250 v. A.C., 150 watts, with silence cabinet and all-wave filter. (List £21/-) £9/10/- each. Both carriage forward.

**RECORD-CHANGERS, ROLA G.12 P.M. SPEAKERS, L.T. METAL RECTIFIERS**. Current goods at bargain prices—please see our advertisement in March issue. Still a few left.

**ELECTRIC MOTORS**. (Don't wait—obtain from our stock at bargain prices!) D.C. 500/250 v. Century, 1 h.p., 35/-, c.f., also repulsion-induction, A.C. 1 h.p., 67/6, c.f. MORSE KEYS, Govt. pattern. Fine plated steel with silver contacts. Fully adjustable, on baseboard 6 in. by 3 1/2 in., 8/6.

M.R. SUPPLIES, 68, New Oxford St., London, W.C.1. Phone: MUS. 2958

# ROLA

## TRANSFORMER LAMINATIONS

Stamped from High Grade Steel, wired and packed in the same consecutive order as they leave the press, ROLA laminations create low transformer costs by their saving on labour. Eight standard sizes of E's and I's are available from stock, together with associated clamps and covers. Core dimensions 1/8" to 1 1/2". A comprehensive Bulletin with design data for manufacturers will be sent on request.

**BRITISH ROLA LIMITED**  
MINERVA ROAD, PARK ROYAL, N.W.10  
WILLEDEN 4322

# Simmonds Speed Nuts

(PATENTS APPLIED FOR)



## HALVE THE NUMBER OF PARTS HANDLED AND ELIMINATE UNNECESSARY ASSEMBLY OPERATIONS

Simmonds Speed Nuts by their amazing flexibility are solving all manner of assembly problems in every industry. Replacing ordinary nuts and lock washers, they reduce the number of parts handled by HALF and effect considerable savings in assembly time and costs. Simmonds Nuts absorb bolt stretch and prevent sinking of the bolt head into wood or soft metal surfaces.

They are unaffected by vibration and absorb any movement due to temperature changes.

For plastics, glass and porcelain, Simmonds Speed Nuts are the perfect fastening.

Cut down your assembly time and costs—adopt the Speed Nut System.

A wide range of Speed Nuts is available from stock. Special types are constantly being designed to suit individual requirements.

We invite Manufacturers and Designers to investigate this modern fastening system. Our Development Department will be pleased to collaborate and work out the most effective designs to solve your assembly problems.



**SIMMONDS AEROCESSORIES LTD**

GREAT WEST ROAD, LONDON.



Longlers

If it's a  
?  
of a first class  
**RADIO-  
GRAMOPHONE  
CONSOLE** or  
**TABLE  
RECEIVER**  
or even a  
**CHASSIS ONLY**  
Get in touch  
with  
**AMBASSADOR**

Specialists also in manufacturers facilities for PERMEABILITY TUNED I.F. TRANSFORMERS, MAINS TRANSFORMERS, COILS, CABINETS and FURNITURE.

For Details and Specifications write to:—

**R. N. FITTON Ltd.**

Hutchinson Lane, BRIGHOUSE, Yorks.

'Phone: 283.

'Grams: Ambassador, Brighouse.

Export Concessionaires:—

**THOMSON & CO.,**  
Edmund Street, Bradford.

'Phone: 7594.

Cables:

Tomcopukka, Bradford, England.

## Lowther

### INDEPENDENT BASS & TREBLE CORRECTOR (Non-resonant)

In these troubled times when the quality of transmission deviates so much from standard a controllable compensating unit of this description is indispensable to the lover of quality.

The corrector proper consists of a 4:1 step-down condenser potentiometer and a resistance-condenser network in conjunction with two double pole 7 way switches, which allow the response at either end of the scale to be raised or lowered independently by altering the ratio of the potentiometer at the desired frequency. It is, therefore, purely aperiodic in its action and the difficulties encountered with the more usual resonant correctors are obviated.

The complete corrector can easily be fitted to any amplifier and is invaluable for adjusting the response to suit gramophone records, room acoustics, etc.

Full technical details on request.

Price complete **5 GNS.**

Less Amplifying Stage **3½ Gns.**

Sent on **7 DAYS APPROVAL** against cash.

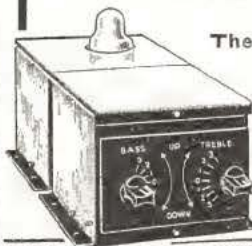

The **LOWTHER  
MANFG. CO.**

Lowther House,  
St. Mark's Road,  
BROMLEY, KENT.

Tel.: RAVensbourne 5225.

## RADIO LABORATORY HANDBOOK

By **M. G. SCROGGIE, B.Sc., A.M.I.E.E.**

Issued in conjunction with "The Wireless World"

"Radio Laboratory Handbook" gives the serious wireless worker complete information from first-hand experience about laboratory equipment, the instruments which are necessary and the correct methods of operating them.

The fundamental principles are fully discussed, as well as the sources of power and signals, instruments and measurements. Ultra-high-frequency work, the working out of results, and reference data are also dealt with. There is a collection of the most useful symbols, abbreviations, formulæ, laws, curves, tables and other data.

A complete index, numbered sections and cross references enable the reader to find what is required without loss of time.

384 pp. 211 illustrations

**PRICE 8/6 NET By Post 9/-**

From all leading Booksellers or direct from the Publishers  
**ILIFFE & SONS LTD.,**  
DORSET HOUSE, STAMFORD STREET, LONDON, S.E.1

W.W.22

## Third Edition of WIRELESS DIRECTION FINDING

BY **R. KEEN, B.Eng.**

A BOOK OF INSTRUCTION AND REFERENCE FOR ENGINEERS, TECHNICIANS, TELEGRAPHISTS AND OTHERS ENGAGED OR INTERESTED IN THE USE OF DIRECTIVE WIRELESS TELEGRAPHY FOR THE NAVIGATION OF SHIPS AND AIRCRAFT.

The third edition of this well-known book deals with the principles of Wireless Direction Finding and gives an account of the circuits and apparatus used in its application to navigation. The Adcock Aerial has a separate chapter covering its principles together with much information on its installation and performance. Further chapters are included on Shore, Ship and Aircraft installations as well as a special section on the choice of a suitable site for the Aircraft Ground D.F., with Adcock Aerials.

Engineering students and research engineers will find useful references to a selected list of some 600 of the more important contributions to the literature of D.F.

800 pages 550 illustrations

PRICE:

**25/- net By post 25/9**

**ILIFFE & SONS LTD.**  
DORSET HOUSE, STAMFORD ST., LONDON, S.E.1

W.W.20

# PREMIER RADIO

## SPECIAL OFFER

DUAL RANGE SCREENED COILS by well-known manufacturer. Aerial or H.F. transformer. All accurately matched. Suitable for Band Pass, Medium and Long Wave operation. Complete with full diagrams.

**2/9**  
EACH

### PREMIER SHORT-WAVE KITS for OVERSEAS NEWS

Incorporating the Premier 3-Band S.W. Coil, 11-86 Metres without coil changing. Each Kit is complete with all components, diagrams and 2-volt valves. 3-Band S.W. 1 Valve Kit, 14/9. 3-Band S.W. 2-Valve Kit, 22/6.

### DE LUXE S.W. KITS

Complete to the last detail, including all Valves and coils, wiring diagrams and lucid instructions for building and working. Each Kit is supplied with a steel Chassis and Panel and uses plug-in coils to tune from 13 to 170 metres.

- 1 Valve Short-Wave Receiver or Adaptor Kit ... 20/-
- 1 Valve Short-Wave Superhet Converter Kit ... 23/-
- 1 Valve Short-Wave A.C. Superhet Converter Kit ... 26/3
- 2 Valve Short-Wave Receiver Kit ... 29/-
- 3 Valve Short-Wave Screen Grid and Pentode Kit ... 48/-

### PREMIER 1940 HIGH FIDELITY AMPLIFIER KITS

Each Kit is complete with ready-drilled chassis, selected components, specially matched valves and full diagrams and instructions.

	Kit of Parts with Valves	Completely Wired and Tested
3-watt A.C. Amplifier	£2 6 6	£3 4 0
3-watt A.C./D.C.	£2 6 6	£3 4 0
6-watt A.C.	£6 2 6	£7 0 0
8-10-watt A.C./D.C.	£5 5 0	£6 2 6
15-watt A.C.	£6 14 0	£8 2 6

Black Crackle Steel Cabinet 15/- extra.  
NEW PREMIER SELF-POWERED RF TUNING UNIT, incorporating a Var.-Mu pentode amplifier followed by a power grid detector. Designed for high-fidelity reception. Wave range 200-560 and 800-2,000 metres. Complete with valves. **£5.5.0**

### GRAMOPHONE MOTORS and PICK-UPS

#### Collaro A.C. Gramophone Motors.

- 100-250 v. 12-inch turntable. Auto. stop. Hum free ... 35/-
- A.C./D.C. Model ... 52/6

#### Collaro A.C. Gramophone Unit.

- Complete motor and pick-up. Auto. stop and start ... 52/6
- A.C./D.C. Model ... 77/6

#### Premier Pick-up Heads.

- Will fit any tone-arm ... 5/3

#### ANOTHER SPECIAL OFFER.

- Piezo Xtal Pick-ups.
- With arm. Famous make. Output 1.7 v. Response 40-8,000 cycles ... **35/-**

### U.S.A. MAINS TRANSFORMERS

at less than pre-war prices.

- Input 110 v. + 220 v. A.C. Output 325-325 v. 120 mA. 5 v. 2 amps. C.T. 6.3 v. 2-3 amps. } **7/6 EACH**
- Input 230 v. A.C. Output 325-325 v. 75 mA. 5 v. 2 amps. C.T. 6.3 v. 2-3 amps. } **6/6 EACH**
- Input 100-250 v. A.C. Output 300-300 v. 80 mA. 4 v. 5 amps. C.T. 4 v. 1 amp. } **6/11 EACH**

### TRANSFORMERS

Auto Transformers. Step up or down. 100-125 v. to 200, 230 or 250 v. A.C., 60 watts, 9/11; 125 watts, 13/6; 250 watts, 18/6.

- L.T. Transformers, all C.T. 4 v. 2-3 a. ... 9/11 6.3 v. 2-3 a. 9/11
- 2.5 v. 5 a. ... 9/11 7.5 v. 3 a. ... 9/11
- 5 v. 2-3 a. ... 9/11 12 v. 3-4 a. 15/-

Lissen Hypernik QPP Driver Transformers. Ratio 8 : 1 ... 4/3

Push-Pull Driver Transformers 6/6

Universal Output Transformers. 11 Ratios. Single or Push-Pull ... 6/6

### PREMIER BATTERY CHARGERS for A.C. Mains.

Westinghouse Rectification complete and ready for use.

- To Charge :
- 2 volts at 1/2 amp. ... 11/9
  - 6 volts at 1/2 amp. ... 19/-
  - 6 volts at 1 amp. ... 22/6
  - 12 volts at 1 amp. ... 24/6
  - 6 volts at 2 amps. ... 37/6

### MOVING COIL SPEAKERS

All complete with transformer. Rola 8 in. P.M.s., 16/6; 10in. P.M.s., 22/6; G.12 P.M.s., 66/-.

#### ENERGISED MODELS

Plessy 8 in., 2,500 or 7,500 ohm field, 7/6; G.12 energised, 59/6. 10in. B.T.H. 1,600 ohm field, less transformer, 11/6.

### SHORT-WAVE CONDENSERS

Trolitul insulation. Certified superior to ceramic. All - brass construction. Easily ganged.

- 15 m.mfd. ... 1/9
- 25 m.mfd. ... 2/-
- 40 m.mfd. ... 2/-
- 100 m.mfd. ... 2/3
- 160 m.mfd. ... 2/6
- 250 m.mfd. ... 2/11

### SHORT-WAVE GEAR

Short-Wave Coils, 4- and 6-pin types, 13-26, 22-47, 41-94, 78-170 metres, 2/- each, with circuit. Premier 3-Band S.W. Coil, 11-25, 19-43, 38-86 metres. Suitable any type circuit, 2/11.

4-pin or 6-pin Coil Formers. Plain or Threaded, 1/2 each.

Utility Micro Cursor Dials, Direct and 100 : 1 Ratios, 4/3.

New Premier 2-Gang S.W. Condenser. 2 x .00015 mf. with integral slow motion, 5/9.

Bakelite Dielectric Variable Condensers. .0003 and .0005 mf. Suitable Tuning or Reaction, 1/6 each.

Short-Wave H.F. Chokes. 10-100 m., 10 d. each. High grade Pie Wound U.S.A. type, 1/9 each.

Jelly Type High Voltage Condensers 1 mf. 3,000 v. working, 7/6 each.

### REPLACEMENT VALVES FOR ALL SETS

Europa Mains Valves. 4 v. A.C. Types A.C./H.L., A.C./L., A.C./S.G., A.C./V.M.S.G., A.C./H.P., A.C./V.H.P., A.C.P., all 5/3 each. A.C./H.P., A.C./V.H.P., 7-pin, 7/6. A.C./Pens. I.H., 7/6; A.C./P.X.4, 7/3; Oct. Freq. Changers, 8/6; Double Diode Triodes, 7/6; 3/- watt D.H. Triode, 9/9. 350 v. F.W. Rect., 5/6; 500 v., 6/6. 13 v. .2 amp. Gen. Purpose Triodes, 5/6; H.F. Pens. and Var.-Mu. H.F. Pen., Double Diode Triodes, Oct. Freq. Changers, 7/6 each. Full and Half-wave Rectifiers, 6/6 each.

#### Triad U.S.A. Valves.

We hold the largest stocks of U.S.A. tubes in this country and are sole British Distributors for TRIAD High-grade American Valves. All types in stock. Standard types, 5/6 each. All the new Octal Base tubes, at 6/6 each.

#### Clearance Line U.S.A. Valves.

U.S.A. Types, 24, 30, 35/51, 55, 56, 57, 58, 71, 65, 2A5, 2A6, 2A7, 2B7, 6A7, 210, 250, all 2 for 3/-.

**YOU MUST HAVE OUR GIANT 1940 ILLUSTRATED CATALOGUE AND VALVE MANUAL OVER 100 PAGES. PRICE 6d.**

## PREMIER RADIO CO.

ALL POST ORDERS to: JUBILEE WORKS, 167, LOWER CLAPTON ROAD, LONDON, E.5 (Amherst 4723).

CALLERS to: Jubilee Works, or 169, Fleet Street, E.C.4 (Central 2833), or 50, High Street, Clapham, S.W.4 (Macaulay 2381).

# It's LIFE that counts!

... in an All-Dry-Battery Portable.

The single battery incorporated in the Marconiphone Model 891 combines H.T. and L.T. and gives approximately 250 hours service. The chassis is built to "mains set" standard, ensuring high efficiency and lasting reliability, under the hardest working conditions.



## The New

# MARCONIPHONE MODEL 891

is designed to fulfil the functions of a Domestic Receiver, an outdoor set for use wherever you go, or as an emergency receiver in the refuge room, A.R.P. shelter, or Warden's post. LIFE combined with maximum efficiency were the first considerations throughout its design.

### EFFICIENCY

The built-in aerial—which is of entirely new design—is in the form of a flat helix winding mounted vertically. This frees the aerial from undesirable electrical effects often caused in portable designs by the proximity of a metal chassis. The winding is self-supporting and waterproof.

The completeness of the design is exemplified by the provision of connections for an outside aerial and earth in cases where reception conditions are difficult, as for instance in steel framed buildings and A.R.P. steel shelters, etc.

The "mains size" dial makes for quick, certain station identification.

It is as efficient as an equivalent wet battery model, yet costs no more to run.

### APPEARANCE

Fine external lines and finish in black leather cloth, make Model 891 suitable for use as a Domestic Receiver as well as outdoors.

The moulded escutcheon combines in one unit, the full size Scale, Controls, On/off and Waveband Switch, and Loudspeaker.

### TECHNICAL SPECIFICATION

Two wavebands: M.W. 200-565 metres: L.W. 850-2,000 metres • Three simple controls comprising Tuner, Volume and combined Waveband—On/off Switch • Station-name and wavelength calibrated scale • Automatic waveband and "off" indicator • High-efficiency lightweight moving coil speaker • Automatic grid bias • Lightweight cabinet covered in black high-grade leather cloth • Smooth-running turntable • High efficiency aerial of new design.

Supplied with Marconiphone combined H.T. and L.T. battery unit (Type B.140) • Provision for connection of separate batteries if desired.

Size: Height 10½ in., Width 14½ in., Depth 7½ in. • Weight with battery 21 lb. 13 oz. • Consumption: H.T. 10 mA; L.T. 0.25 Amp.

AND YET MARCONIPHONE MODEL 891 COSTS ONLY **£8.10.6** COMPLETE

Ask your Local Marconi-Man to demonstrate it, then, take the back off and look inside!

THE MARCONIPHONE COMPANY LIMITED, BOURNES BRIDGE, HAYES, MIDDLESEX



# The Wireless World

COVERING EVERY WIRELESS INTEREST

30th Year of Publication

Proprietors : ILIFFE & SONS LTD.

No. 1054

VOL. XLVI. No. 6

Editor :  
HUGH S. POCOCK.

APRIL 1940

Editorial,  
Advertising and Publishing Offices :  
DORSET HOUSE, STAMFORD STREET,  
LONDON, S.E.1.

## Contents

Telephone : Waterloo 3333 (50 lines).  
Telegrams : "Ethaworld, Sedist, London."

COVENTRY : 8-10, Corporation Street.  
Telegrams : Telephone :  
"Autocar, Coventry." 5210 Coventry.

BIRMINGHAM :  
Guildhall Buildings, Navigation Street, 2.  
Telegrams : Telephone :  
"Autopress, Birmingham." 2971 Midland (5 lines).

MANCHESTER : 260, Deansgate, 3.  
Telegrams : Telephone :  
"Iliffe, Manchester." Blackfriars 4412 (4 lines).

GLASGOW : 26B, Renfield Street, C.2.  
Telegrams : Telephone :  
"Iliffe, Glasgow." Central 4857.

PUBLISHED MONTHLY.  
Price : One Shilling  
(Publication date 20th of preceding month.)

Subscription Rates :  
Home and Abroad, 14/- per annum.

As many of the circuits and apparatus described in these pages are covered by patents, readers are advised, before making use of them, to satisfy themselves that they would not be infringing patents.

EDITORIAL COMMENT .. .. .	195
CONSTANT POTENTIAL RECTIFICATION. By S. A. Stevens and A. H. B. Walker .. .. .	196
PROBLEM CORNER.. .. .	199
IGNITION INTERFERENCE SUPPRESSION. By C. Attwood and B. Cole .. .. .	200
FOR MORSE PRACTICE. .. .. .	203
UNBIASED. By "Free Grid" .. .. .	204
TONE CONTROL IN HEARING AIDS. By T. S. Littler .. .. .	205
SINGLE-VALVE SETS .. .. .	207
NEWS IN ENGLISH FROM ABROAD .. .. .	209
GETTING THE BEST FROM RECORDS: PART III— MORE ABOUT TONE CORRECTION CIRCUITS. By P. G. A. H. Voigt .. .. .	210
COSSOR MODEL 71B: Test Report .. .. .	214
CURRENT TOPICS .. .. .	216
LETTERS TO THE EDITOR .. .. .	219
THE DIFFERENTIAL CALCULUS—EVERYBODY KNOWS IT. By "Cathode Ray" .. .. .	221
ULTRA-SHORT-WAVE AERIAL SYSTEMS. By F. R. W. Strafford .. .. .	224
FAULT FINDING BY SIGNAL TRACING .. .. .	228
RANDOM RADIATIONS. By "Diallist" .. .. .	230
RECENT INVENTIONS .. .. .	233

## TROPHY brings you the World's opinions and NEWS!

"Wireless World" reports (see Feb. issue) "... The TROPHY 6 is lively down to the shortest wavelengths ..."

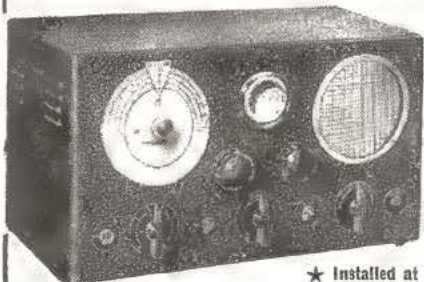

FOR War news—flashes and bulletins, entertaining programmes and to bring into your home every worth-while radio signal in the World—for all of these—the TROPHY 6 (illus. on left) is a wise investment. This A.C. 6-valve superhet employs electrical bandspreading and tuning refinements of the communication type of set. Continuous wave-range 6.5 to 550 metres. M/C speaker is built-in with provision for alternate use of phones... for performance and reasonable outlay, the TROPHY 6 is confidently recommended. Buy now at a saving.

Fully Guaranteed **£10-19-6** Or on Easy Terms.

★ Installed at RADIO ROYAL, Europe's largest Press listening post.

● Please send for new TROPHY brochure. Models from £7 to £14.

### New 2-Stage R.F. AMPLIFIER

Of special appeal to "The Wireless World" reader who appreciates the shortcomings of his existing receiver. This new PRESELECTOR—for use in front of any set—ensures increased range, volume, selectivity and sensitivity and appreciable image suppression. Harmonic tuning is provided with a continuous coverage of 7 to 550 metres. Uses two "E" type R.F. pentodes with built-in power-pack for all A.C. 200/250 v. 40-100 cycle supplies. Fully guaranteed. **£7-8-6**

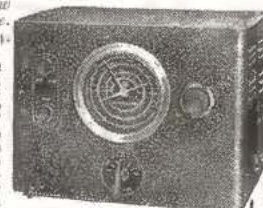

PETO SCOTT CO. LTD., 77, (WM6) City Road, London, E.C.1 Tel.: Oldisold 9870, WEST END Showroom: 41, High Holborn, W.C.1.

MANCHESTER: Wellworth's Radio. SCOTLAND & NORTH: Clydesdale Supplies.

# TWO Fine WAR BABIES

I expect you'll see our public advertisements of the '90' Standard Mains Table Superhet and the '89' Economy Battery Superhet. So far as *you* are concerned, I am going to express no opinion of them, but wait to hear what *The Wireless World* and you yourselves have to say about them in due course. You know that any Murphy dealer is pleased to show and demonstrate the models to you, and I hope lots of you will give them the chance to do so.

They are our first answers to wartime needs and difficulties and you will find them highly interesting. *That's* a good non-committal sort of word, isn't it?

E. J. POWER, *Managing Director.*



*All Murphy Sets, exclusive of valves and batteries, guaranteed for a year. Prices do not apply in Eire.*

MURPHY RADIO LIMITED, WELWYN GARDEN CITY, HERTFORDSHIRE

# MURPHY RADIO

# The Wireless World

COVERING EVERY  
WIRELESS INTEREST

ESTABLISHED  
1911

No. 1054. Vol. XLVI. No. 6

APRIL 1940

Price One Shilling

## Editorial Comment

### An Unwanted G.P.O. Service

**W**E imagine that few tears were shed over the recent publication of the statement that the Post Office had decided to postpone until after the war its scheme for distributing broadcast programmes over the telephone wires. According to the statement made in the House of Commons by the Postmaster General, it has been decided that any advantages likely to accrue from the proposed scheme would not justify the diversion of capital and labour from other wartime activities. With that conclusion we are in the fullest agreement, but it seems slightly paradoxical that war should be given as a reason for shelving a project that was originally put forward as a measure of national security.

It was a coincidence that on the very day the P.M.G.'s decision was announced Dr. Walmsley, of the G.P.O. Wire Broadcasting Branch, read before the Wireless Section of the Institution of Electrical Engineers a most comprehensive and valuable paper on the various methods—both audio- and radio-frequency—of distributing programmes by means of metallic conductors. The author made out a good case for wire broadcasting on the grounds of its relatively greater immunity from noise as compared with radio transmission through space. He also stressed the point that it permitted a wider bandwidth; that, too, cannot be denied so long as broadcasting channels are divided up on the present basis, but we all look forward to the day when a spirit of international co-operation will prevail, and wider channels will be allotted. Further, better use could be made of ultra-short waves for high-fidelity broadcasting.

As Dr. Walmsley's paper was presented before the Wireless Section of the I.E.E., it might at first

sight have been expected that the discussion which followed would have developed into a pitched battle between the supporters of wire and wireless, with weight of numbers in favour of the latter. But there is really no reason nowadays for bickerings between the opposing schools. In any case, carrier or radio-frequency methods of distribution are strictly within the competence of wireless engineers; they employ basically the same technique and for their reception employ what is essentially a wireless receiver. Simple audio-frequency distribution is rather a different matter, but is not in the limelight at the present moment. We have reached the conclusion that its application is likely to be mainly limited to special cases, as for serving compact communities whose requirements in the matter of programme choice are not particularly exacting.

Discussion at the I.E.E. meeting was liveliest between the advocates of radio-frequency distribution over the electric supply mains, headed by Mr. P. P. Eckersley, and the adherents of the Post Office scheme. A strong argument in favour of the mains is that they serve roughly five times as many households as do the telephone lines. It was stated, however, that the mains are noisier, and that the technical problems of distribution are more serious.

We have gathered the impression that there is no public demand for the Post Office scheme, and that among wireless people in particular there is a surprising depth of feeling in favour of preserving the freedom of the ether. Rightly or wrongly, they regard a government-controlled system of broadcast distribution as a step towards totalitarianism. The war has shown that there is little chance that wireless broadcasting will ever be overshadowed by any system of wired distribution.

# Constant Potential Rectification

## A NEW SYSTEM DESCRIBED

By S. A. STEVENS, A.C.G.I., D.I.C., B.Sc. (Eng.), A.M.I.E.E., and A. H. B. WALKER, A.C.G.I., D.I.C., B.Sc. (Eng.),

Research Department, Westinghouse Brake and Signal Co. Ltd.

**D**URING the past ten years there has been a rapidly increasing need for means of obtaining a constant output voltage from a rectifier, irrespective both of the load and normal fluctuations of mains voltage. Designers have striven to avoid the use of accumulators for the operation of amplifiers, oscillators and measuring instruments, and to replace these accumulators by mains units. In general, the mains are 50-cycle AC, and in consequence the mains unit will incorporate a rectifier, and probably smoothing equipment. The rectifier and its smoothing equipment, partly through their internal resistance and partly through the action of reservoir condensers, bring about large variations in output voltage when the load current changes. The supply voltage, too, may vary up to the statutory limit of  $\pm 6$  per cent., and in many cases if one is to use the mains supply it is essential to minimise both of these effects. The frequency stability of the time-controlled grid supply is fortunately such that the effect of frequency variation on the rectifier output can be neglected. The regulation of the rectifier and smoothing circuit is particularly troublesome with valve amplifiers and oscillators which do not work under Class A conditions, and the problem is therefore a major one to amateur transmitters in order to obtain suitable anode supplies which will not change with variation in modulation or "keying" of the transmitter. Even where the load can be kept constant, the variation in mains voltage may still have a serious effect upon the performance of the equipment, and this statement applies particularly with

A description of a novel form of constant potential equipment which would appear to possess many advantages. No DC saturation is employed, and the compensation for sudden changes in mains voltage and load current is therefore immediate. The circuit also provides conversion from single- to three-phase current so that the output ripple is very low. The characteristics of the circuit render it particularly suitable for use in a fully automatic floating battery system

regard to oscillators which are required to remain very stable for measurement purposes, and other forms of measuring devices, including in particular DC amplifiers.

In a totally different category will

problem is, indeed, so difficult that in the past it has been impossible to solve it satisfactorily by static means.

On account of the types of application of constant potential systems, the following points may be set down as the desirable qualities:—

- (1) Close approximation to constant potential under any conditions of load, mains voltage, temperature and time.
- (2) Immediate compensation for transient changes in load and mains.
- (3) High electrical efficiency and input power factor.
- (4) Low ripple percentage in output voltage.
- (5) Facilities for adjustment of output voltage.
- (6) Economic use of materials.
- (7) Rapid collapse of voltage with overload to provide self-protection.

For small power work, neon discharge tubes have been used as voltage limiters. The load is fed through a series impedance from the rectifier, and is shunted by the discharge tube. The effect of the discharge tube is to limit the voltage across the load to a constant value irrespective of load and mains fluctuations within reasonable limits.

The system is clearly inefficient from a power point of view, but is simple and effective. It is worthy of note that it corrects all sources of voltage variation simultaneously, and also achieves stabilisation by using as a constant the physical property of the gas discharge, which is affected only by temperature and ageing. Adjustment of voltage is impossible except by the changing of neon tubes.

Other static systems all make use of the magnetic properties of iron,

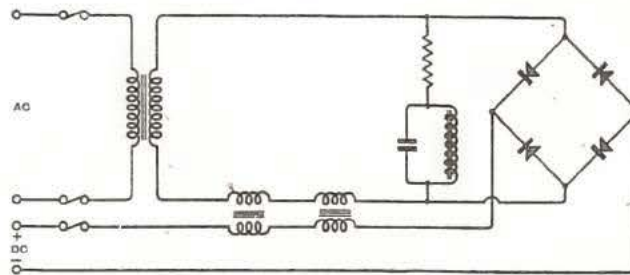

Fig. 1.—An early form of constant potential equipment where load compensation and mains compensation are separately applied.

be found a need for battery chargers of an entirely automatic type across which can be left floating the battery on a varying load without attention for long periods. This latter application is a particularly exacting one, because quite small changes in the output voltage of the rectifier will mean very large changes indeed of the charging rate of the low-impedance battery connected to it. The

**Constant Potential Rectification—** and in general the load and mains effect on output voltage must be compensated separately. Load compensation has been achieved by using a DC reaction circuit in which

only, i.e., to avoid alternating currents being directly transformed into the DC circuit, since waveform distortion prevents simple winding balance.

Mains compensation can be added to this circuit, and methods already used include barretters and semi-resonant shunt circuits (a gain using the magnetic properties of iron).

As an example of such a method, the Westinghouse "C.P." rectifiers used load compensation of the

circuit as the load current increases from zero to full-load value.

The circuit which is used to produce this result is shown in Fig. 5, and it will be seen that it consists simply of two transformers, T1 and T2, having their primaries connected in series (one being shunted by a condenser), and their secondaries in Scott connection. By suitable design it can be so arranged that at full load the voltages across the primaries are displaced by 90 deg., that across T1 (i.e.,  $V_1$ ) leading the mains voltage by 45 deg., and  $V_2$  lagging by 45 deg. This forms a two-phase system which can be applied directly to a rectifier, but better results are obtainable by using the Scott connection of the secondaries to provide a three-phase system. At smaller

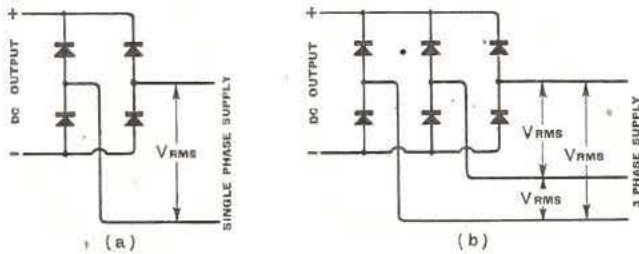

Fig. 2.—A single-phase full-wave bridge connected rectifier is shown in diagram (a); the addition of two rectifying limbs, as in diagram (b), results in a three-phase rectifier of the same type.

a direct current proportional to the load current is used to saturate, to a variable degree, a reactance connected in the AC circuit to the rectifier. The electrical efficiency is low, the design is largely empirical, and difficulty is experienced in making the reaction work in the one direction

DC reaction circuit type with mains compensation of the semi-resonant shunt type (see Fig. 1).

Using a single-phase bridge-connected rectifier as shown in Fig. 2(a), having a sinusoidal input of  $V$  volts RMS, the output voltage wave will be as shown in Fig. 3(a), and will have on open circuit a mean output voltage of value  $0.9 V$ .

If two further rectifier limbs are added to form a three-phase bridge connected rectifier, as shown in Fig. 2(b), and the input line voltage is maintained at  $V$  volts RMS, the mean open circuit voltage will rise to a value of  $1.35 V$ , the output voltage wave being as shown in Fig. 3(b).

In both cases the voltage will fall with load, and the actual extent of this regulation for typical rectifiers is shown in Fig. 4. It will be apparent from this graph that at full load the output voltage of the three-phase rectifier is still a little in excess of the open-circuit voltage of the single-phase rectifier, and on this fact the new system depends for its operation.

To secure load compensation it is only necessary to use a circuit which will progressively change from a single-phase to a three-phase rectifier bridge cir-

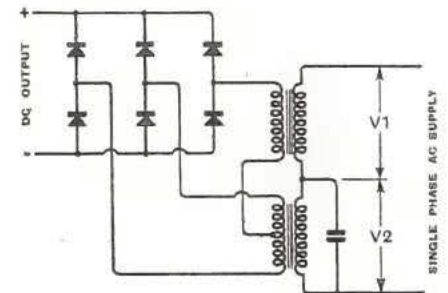
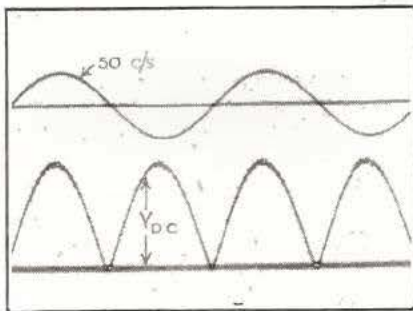

Fig. 5—Fundamental circuit of the new constant potential system. A phase-splitting circuit is used on the primary side, and the transformer secondary windings are Scott-connected to provide a three-phase supply to the rectifier at full load. Variations in load current or supply voltage result in phase swinging which controls the DC voltage within fine limits.

values of load current these conditions do not apply, the voltage  $V_2$  diminishing, and the voltages  $V_1$  and  $V_2$  swinging together so that their displacement is no longer 90 deg. By this means one phase of the three-phase output is progressively lost as the load current is reduced, so that the circuit reverts to single-phase operation, from transformer T2 only, at no-load.

The same circuit also provides a very high degree of



(a)

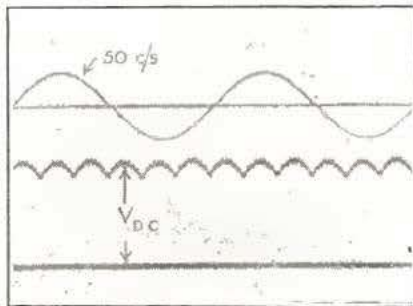

(b)

Fig. 3.—Oscillogram (a) shows the output voltage wave of the single-phase rectifier shown in Fig. 2 (a). The superimposed high-frequency ripple results from the tooth ripple of the alternator feeding the rectifier. Oscillogram (b) represents the output of the three-phase rectifier shown in Fig. 2 (b).

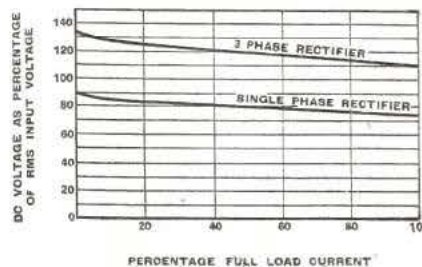

Fig. 4.—Typical regulation curves for single-phase and three-phase bridge-connected rectifiers. The DC output voltage is shown as a percentage of the RMS input line voltage.

<sup>1</sup> British Patent No. 493,362.

### Constant Potential Rectification—

mains compensation, since the transformer primary voltages  $V_1$  and  $V_2$  must always vectorially sum to the mains voltage. A change in the latter consequently produces a change in magnitude, and in phase displacement between them, these two effects neutralising one another in their effect upon the DC output voltage.

The performance of output voltage to a base of load current can be varied between very wide limits as may be required according to the application. Such adjustment is divided into two parts, that for general level and that for slope. The latter can be made positive, zero or negative as the current is increased.

The applications of this principle fall into two main groups—the first to operate equipment direct from AC mains, and the second to float an accumulator automatically at a constant voltage.

To distinguish between these two groups, which clearly need different performance, two separate trade names have been registered. The name "Noregg" is applicable to the first group, and the name "Westat" to the second.

The performance obtained from normal commercial sets is so good that it is impracticable to illustrate the regulation curves obtained under the varying conditions by means of any graph plotted to a true zero within the space limitation of these pages. The following table is, therefore, given to show the performance of a typical set of 600 watts full-load rating, adjusted for zero slope:—

Load Current (amps.)	DC Output Voltage		
	Supply 200 V.	Supply 225 V.	Supply 250 V.
0	50.6	50.4	51.1
2	49.2	50.0	50.2
4	49.0	49.5	50.0
6	49.2	49.8	50.0
8	50.0	50.0	49.5
10	50.4	50.0	49.3
12 (full load)	50.0	50.2	49.2

Performance of this type is obtainable at either low or high voltage from, say, 12 volts upwards, and is also obtainable in any size of equipment from 15 watts upwards,

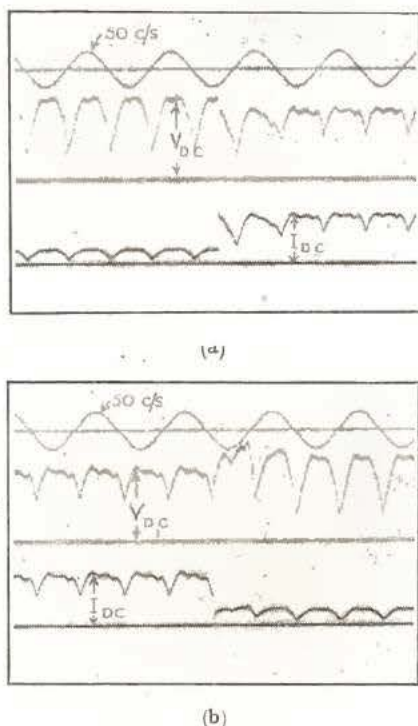

Fig. 6.—Oscillograms showing the rapid response of the circuit to sudden changes in load. At (a) the load current has been suddenly increased from  $\frac{1}{4}$  to  $\frac{3}{4}$  full-load, and at (b) it has been suddenly decreased. The mean DC voltage remains the same, the waveform merely changing. In both cases recovery of mean voltage is complete in less than one cycle.

so that there are no limitations such as are to be found in the previous methods employed for obtaining constant potential.

The response of the circuit to transient changes in load or mains voltage is immediate, as opposed to the DC reaction circuit where no response can be obtained until the saturation of the core has taken place (and this can only be brought about by the rise of a direct current through the inductive circuit). The rapidity of the response is shown by the oscillograms in Fig. 6, where it can be seen by reference to the 50-cycle timing wave that recovery is complete in less than one cycle. Where this transient response is of importance, the equipment will always be used with a smoothing circuit, and the time constant of the smoothing circuit will be long compared with this recovery time. The load or mains voltage transient will, therefore, have no effect on the output voltage, provided that the

output impedance of the smoothing filter is made low compared with the load impedance, so that transient changes in load current do not cause transient voltages of appreciable magnitude to be generated within the filter itself.

It is clear from a consideration of the principle on which the circuit works that the control of output voltage is obtained without any waste of power, so that the overall efficiency can be made as high as that of a normal transformer and rectifier circuit. Furthermore, as the positive and negative reactive components cancel one another at full load in order to produce equal and opposite displacements of the voltages  $V_1$  and  $V_2$ , the power factor becomes almost unity. Practical results obtained on test on the 600-watt set referred to above are: full-load efficiency 73.4 per cent., and power factor 0.935.

As the supply to the rectifier at full load is practically balanced three-phase, the output ripple is of the same order and frequency as for a normal three-phase full-wave rectifier. In actual practice a typical figure for the RMS value of the ripple expressed as a percentage of the DC output voltage is 10 per cent., mainly at a frequency of 300 cycles per second (or six times the supply frequency), as may be seen in the oscillogram in Fig. 7.

This compares very favourably with a single-phase full-wave recti-

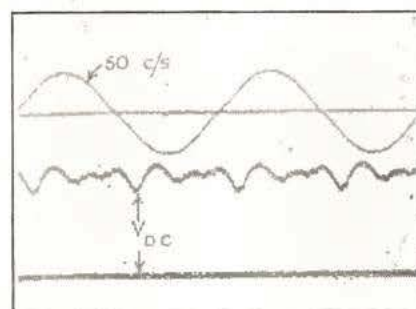

Fig. 7.—Typical unsmoothed output voltage wave of the "Noregg" circuit at full load. The RMS value of the ripple is approximately 10% of the mean DC voltage, compared with a figure of about 50% for a normal single-phase rectifier.

fier output which would have a ripple percentage of about 50 per cent. at 100 cycles per second. The increase of frequency results in an

### Constant Potential Rectification—

increase of effectiveness of any given filter circuit by nine times, while, since the initial ripple is only one-fifth of the single-phase rectifier ripple, it would be correct to say that the output of a "Noregg" or "Westat" is about forty-five times as easy to smooth as the output of a single-phase full-wave rectifier.

At light loads when the rectifier is no longer functioning as a three-phase one, the output is substantially single-phase full-wave rectified, and one would expect a ripple percentage of about 50 per cent. However, this does not arise, since the resultant AC input wave to the single-phase

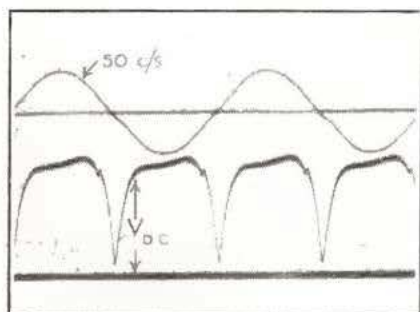

Fig. 8.—Typical unsmoothed output voltage wave of the "Noregg" circuit at no-load. The flat-topped wave results in a ripple of only about 25% of the mean DC voltage.

portion of the rectifier is not sinusoidal under these conditions, but is flat-topped, and the RMS output ripple percentage even at open circuit does not exceed approximately 25 per cent. of the mean output voltage. This fortunate effect is shown in the oscillogram in Fig. 8.

Under overload conditions, the primary phase displacement will exceed 90 deg., with a corresponding loss of balance of the three-phase line voltages. This brings about a similar reversion to single-phase as a reduction in current, and therefore leads to a rapid collapse of output voltage. Clearly this forms a valuable protection for the rectifier and its associated equipment against severe overloading, which can very easily occur with other forms of load-compensated circuits.

As previously explained under "mains compensation," the primary phase displacement varies with the mains voltage, and therefore the value of load current at which it becomes 90 deg. will change with the

applied voltage. Total compensation can therefore be obtained up to a value of load current dependent upon the range of mains voltage over which the equipment is to function, and this point is normally chosen to cover a mains range of the order of 200 to 250 volts. At lighter loads than this full-load value, full correction will still be obtained even at very much reduced mains voltages. For example, at about one-half full-load current the mains voltage can actually be varied over a range of 3 to 1 before the output varies appreciably. Although it would not normally be necessary to obtain this performance, some application may arise in which this property would be extremely valuable.

From what has already been said about transient variations in mains and load, it will be seen that it is necessary for the filter to be designed to have an input time-constant long compared with the transient recovery time of the "Noregg" circuit, and to have an output impedance small compared with the load impedance at the lowest frequency of load pulsation. The filter circuit must not commence with a reservoir or tank condenser as this would charge up to the peak value of the single-phase ripple at light loads and ruin the regulation.

Since a reservoir condenser is inadmissible, it is clear that a battery, if connected direct to the rectifier output, would have the same effect at light loads, and it is therefore essential to use a filter choke preceding the battery to prevent this. The characteristics of the set may be adjusted to any required shape, and in practice, two methods of operation with a battery are available.

The first may be described as the "cyclic" method. If an output curve having a portion of negative slope is used, an automatic charging effect can be obtained, the current rising rapidly to full-charge rate when the battery drops to a critical value, and cutting down to a trickle charge rate at a critical upper voltage limit. This system has two main disadvantages; one is that the battery is continuously taken through a series of cycles of charge and discharge which materially shortens its life, while the second and most serious is that there is no

guarantee that the battery will not be at the semi-discharged portion of the cycle when a mains failure occurs and full stand-by capacity is required. In addition to this, the system depends for its operation on variations in battery voltage, and this may often be objectionable.

These disadvantages are overcome by using the "floating" method, as the excellent output stability, coupled with ease of adjustment of output slope, makes possible the operation of a fully automatic floating battery system in which the battery can always be maintained within the required limits of voltage, and in which the possibility of overcharging or discharging under all conditions of load and mains voltage is absolutely eliminated.

## Henry Farrad's Problem Corner

### No. 45.—A Hard Bargain

"Killarney,"

Shamrock Green, London, W.13.

Dear Henry,

After having dropped the "home construction" game for years, I have been hurriedly putting together a portable set to take around with me when I join up shortly. The components are whatever I had lying around, and are mainly of antiquarian interest. The set has to be compact, of course, and I am providing for medium wavelength only, and using the smallest variable condenser I could find. Unfortunately it didn't seem to be big enough to cover the whole waveband, as it just failed to take in Athlone—a station I particularly want to include.

So I supplemented it with the smallest fixed condenser I had—a ceramic 25 m-mfd.—which, when connected in parallel, brought the wavelength up just enough (and no more) to cover Athlone. Of course, I *expected* the wavelength at the other end of the scale would be increased, too, so that I would lose a station, but I didn't bargain for losing a whole lot of them in exchange for the one I'd gained. Even though some of those at the short-wave end are of dubious value, others (such as Dublin) are quite interesting, and, anyway, I'm worried about having to make such an unequal exchange, so would be obliged if you would put your finger on what is wrong.

Yours ever,

Patrick.

For Henry Farrad's solution see page 215.

# Ignition Interference Suppression

HOW IT AFFECTS MOTOR CAR PERFORMANCE

By G. ATTWOOD AND B. COLE

**T**ECHNICAL literature dealing with the effect of interference suppression devices on the performance of a motor car is unfortunately almost non-existent, and the motorist with no interest in television or short-wave reception cannot be expected voluntarily to suppress his engine until he is convinced that the performance of his car will not be adversely affected.

The considerable amount of investigation that has been conducted during the past three or four years on the methods by which short-wave interference from ignition systems of motor cars may be reduced has culminated in the production of a British Standards Specification which recommends the degree of suppression considered necessary for radio and television services and gives practical details of the means by which this may be carried out. At the same time, there is practically no published information available dealing with the effects of suppression on the engine of a motor car or on the performance of the vehicle.

A number of reasons for this almost complete absence of reliable information suggest themselves. Ignition technique is a highly specialised subject, and considerable knowledge of the process of ignition is necessary before it becomes evident even where to look for the modifications introduced by suppression devices. An accurate analysis of engine performance under the varying conditions of road usage is practically impossible even to a skilled tester, and the average car owner can hardly be ex-

pected to form a reliable estimate of the effect of suppression on the performance of his vehicle. The tests necessary to obtain accurate data require the facilities of a well-equipped test-house, and the work involved for a complete determination of any differences in engine behaviour for even a single engine is both laborious and costly. For this purpose an ordinary dynamometer test of engine horse-power and fuel consumption under full-throttle conditions at normal working temperature is practically useless, for under these conditions the effects of suppression are generally least pronounced. The modern tendency to strive for extreme fuel economy further complicates matters.

The interfering disturbance produced by the electrical ignition systems of internal combustion engines is distributed over a very wide range of frequencies embracing all frequencies used by the various broadcasting services. Suppression devices may be fitted to a motor vehicle with the intention of suppressing medium-

and long wave-radiation that would interfere with a receiver fitted to the car, or to suppress short-wave and ultra-short-wave interference with radio and television sets in houses adjacent to motoring highways. These two requirements involve distinctly different technical considerations. In the former case, voltage regulators, electric windscreen wipers, dynamos and other com-

ponents may cause interference, but the interference from the ignition system generally produces by far the most serious trouble. In the latter case only the

There is a dearth of published information on the precise effect of ignition interference suppression on the performance of the petrol engine, and so it is not surprising that many misconceptions have arisen. This article describes the process of ignition and explains the effects of suppression. A concluding instalment will analyse in greater detail the effects on engine performance, and means of minimising them will be suggested.

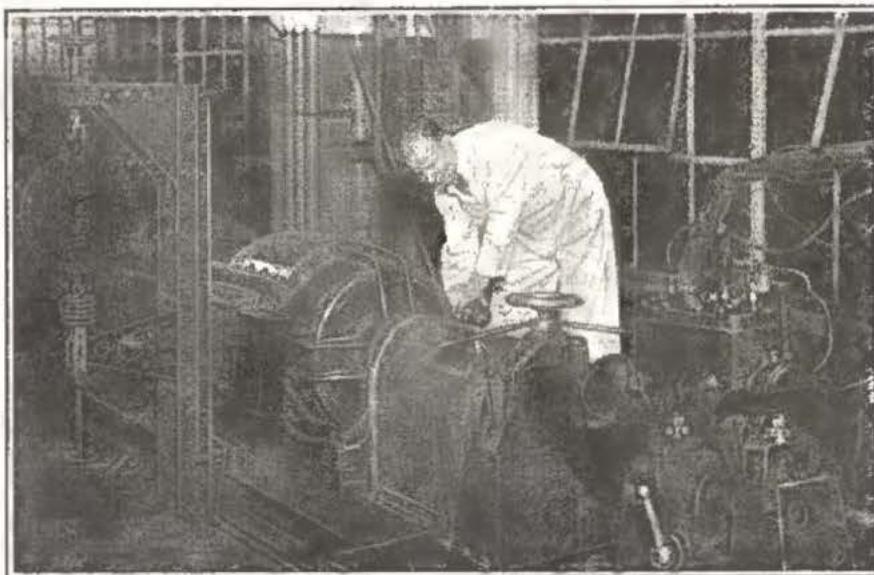

The ordinary motorist cannot form a reliable estimate of the effects of suppression; the facilities of a well-equipped test-house are necessary. This photograph shows a 10-h.p. Ford engine, with suppressors fitted, undergoing a test in the Dagenham Works.



## Ignition Interference Suppression—

ignition system is likely to cause serious interference, but the disturbance produced in this way is very severe, particularly at very high frequencies. These articles will consider the ignition system only, for no other component of a car is likely to be adversely affected by suppression devices. Only resistance suppression is dealt with, for this is by far the most popular method amongst private motorists and it may be made sufficiently effective at all frequencies by suitable disposition and design of the resistors. At the same time, there are no reasons for supposing that the ultimate solution to electrical ignition interference will be achieved this way: there are reasons for believing that choke or screening methods, or perhaps a combination of all three methods, will be the ultimate means by which this kind of disturbance will be cured.

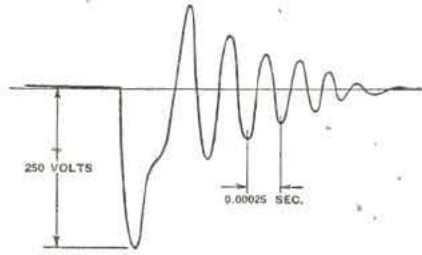

Fig. 1.—Voltage surge on condenser in primary circuit of a 6-volt ignition coil.

Before proceeding to the ultimate effects of suppression on the engine, the effects to be expected on the ignition system itself must first be appreciated, and this requires a more complete knowledge of the process of ignition than is generally available from text-books. The coil method of ignition will be assumed in these articles, for almost all private cars are fitted with this system, but the conclusions apply equally to magneto ignition, for, from this point of view, there are no major differences between the two systems.

The voltage required to ignite the explosive mixture in a cylinder is normally several thousand volts, but with certain engines, and during adverse conditions with all engines, it may rise to 10,000 volts or more. This high voltage is induced in the secondary of an induction coil by the collapsing flux when the contact breaker interrupts current in the primary circuit of the coil.

### Condenser Action

A non-inductive condenser is connected across the contact breaker. As the contact points open this condenser charges up to a high voltage, for it absorbs the inductive voltage from the primary of the coil, Fig. 1, which shows a peak voltage of 250 volts, indicates a typical voltage surge across the condenser of a 6-volt coil. As the condenser voltage builds up, the charging current diminishes and the inductive voltage of the coil falls below the condenser voltage. The condenser then discharges through the coil, thereby starting a train of oscillations whose frequency is determined by the inductance of the coil and the capacity of the condenser. These oscillations, whose frequency is generally of the order of 3,000 or 4,000 c/s, are at far too low a frequency to produce disturbing radiation, and it appears

that from the point of view of interference the oscillating current in the primary circuit of the coil may be ignored. The effect of suppression resistances on the behaviour of the primary circuit cannot, however, necessarily be ignored. This effect will be considered later, after the function of the condenser has been dealt with more fully.

The primary winding is tightly coupled to a secondary winding of high turns ratio and of resistance 4,000 or more ohms. The rapidly collapsing lines of force produced on opening the contact breaker points cut the secondary turns and induce in them the high voltage, which is distributed to each of the plugs in the correct sequence by the distributor.

### The Secondary Circuit

Referring to Fig. 2, it will be seen that the high-tension circuit consists of a wire A from the secondary of the coil to the distributor, wire B from the distributor to the insulated electrode of plug No. 3, the spark at the plug gap and the earth return through the engine cylinder block. The wire A, distributor rotor, wire B and plug electrode, together with a portion of the self-capacity of the coil secondary winding, constitute a group of components forming a condenser whose capacity to earth is in parallel with the gap of sparking plug No. 3. As the secondary voltage builds up, current will flow into this small condenser, charging it to a voltage comparable with the voltage induced in the secondary of the coil. The voltage builds up to the point at which the plug gap is so highly stressed that it breaks down and the condenser discharges through the gap. The voltage required to break down the gap depends upon the temperature and pressure inside the cylinder, the steepness of the voltage wave-front and a number of other factors.

This condenser formed by the sparking plug electrode and associated connections discharges itself to a comparatively low voltage in an exceedingly small interval

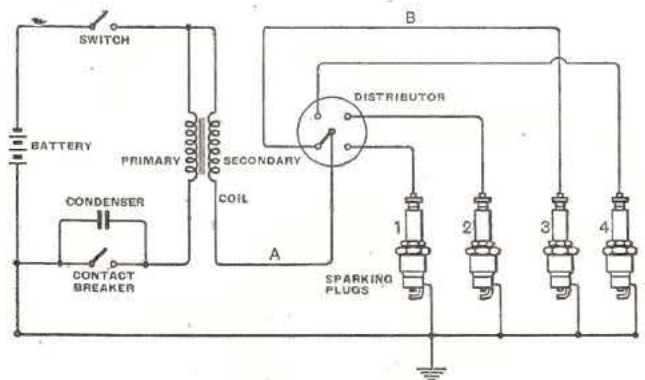

Fig. 2.—A conventional ignition circuit without suppression.

of time and in the process passes a current of almost unbelievable magnitude. This violent shock is the direct cause of the radio interference produced by high-tension ignition systems.

Following this intense capacitive discharge, current continues to flow until the rate of change of flux

## Ignition Interference Suppression—

is unable to maintain the potential above the extinguishing voltage of the gap, which is, of course, very much lower than the potential required to break down the gap in the first instance. The intense discharge that initially breaks down the gap, whose duration is not usually greater than a micro-second, is known as the capacity component of the spark. The discharge that follows, after the gap has become ionised, lasts for several milli-seconds and is known as the inductive component. The difference in the appearance of a spark when suppressors are fitted to an engine is due to the alteration in the inductive component, but the effect of suppressor resistances on the capacity component is equally serious.

Means are available for separating these two components of the spark, and it is possible to produce a spark by static means which has practically no inductive component. By experiments along these lines it has been conclusively established that under normal working temperature conditions with a truly gaseous mixture the process of ignition depends on the capacity component alone and, in fact, too large an inductive component may even be undesirable. The actual energy that must be delivered to the spark to produce ignition is very small, and for ordinary warmed-up operation the electrostatic energy stored in the condensers associated with the plugs and cables when they are charged up to the sparking voltage is sufficient to ignite the mixture. The capacity component is, however, not

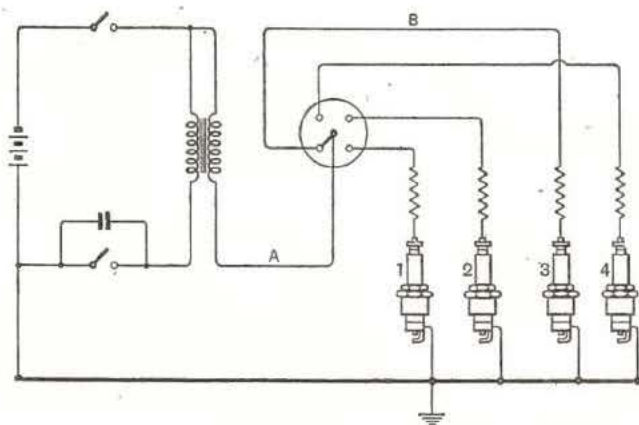

Fig. 3.—Ignition circuit with suppressor resistances inserted in series with each sparking plug.

always sufficient to ignite an improperly vaporised fuel, so the inductive component becomes important when the engine is operating under difficult conditions, and this is especially so during the starting period. The coil must also supply energy to any leakage due to imperfect insulation of any part of the secondary circuit.

It should be realised at this point that it is impossible to visualise completely the modification to be expected from suppression resistances, for the precise manner in which the mixture in a cylinder is ignited is still controversial. Thermal effects do not wholly explain the mechanism of ignition, which appears to be primarily

a shock effect on the mixture as well as on neighbouring radio aerials! The energy liberated by a spark has no effect on the horse-power developed by the engine, and the only way in which a feeble spark can cause loss of power is by failing to ignite the fuel.

It is now possible to consider the first effects of resistance suppression on the operation of an ignition system, namely, the modifications produced to each component

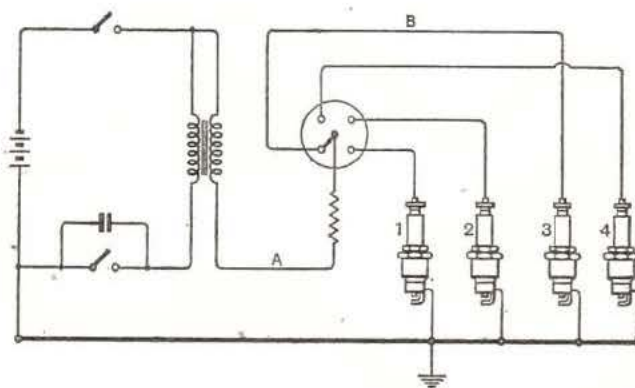

Fig. 4.—Suppression by means of a single resistor in the distributor lead.

of the spark. If suppression is achieved by resistances adjacent to each sparking plug, it can be seen from Fig. 3 that the capacity of wire A, the distributor, and most of wire B has been stoppered off so that the capacity available for the capacity component of the spark is less than before, and the intensity of the initial unchecked rush will be reduced. Moreover, each plug circuit now contains a resistance of a value out of all proportion to the original resistance of the circuit, and consequently the current output of the inductive component will be very much less than its value when resistors are absent. The current reduction in the latter case is generally of no particular importance, but the limitation of the capacity discharge may be more serious, particularly when the engine is idling and during starting.

### The Single-Resistance Method

The method of suppression involving a single suppressor in the distributor lead will limit both components of the spark in a similar way, but it will be seen from Fig. 4 that the reduction of capacity across the spark gap is considerably less than in the case of separate suppressors fitted to each plug. A single suppressor in the distributor lead can therefore be expected to have a lesser effect on engine performance (and on interference suppression) than equal-valued resistances in the plug leads. The inductive component of the spark is not affected by the position of the suppressors.

Another effect of suppression resistances is to increase the high-tension voltage delivered by the coil. This is of no importance with coils of modern construction; in fact, a coil fitted with resistors is less likely to break down owing to the fact that the surge can do more harm to the first few layers of the coil than the increased voltage can do to the secondary insulation.

## Ignition Interference Suppression—

By considering the equivalent oscillatory circuit, consisting of distributed inductance, capacity and resistance in leads A and B, together with lumped capacities at the ends of these wires, it may be seen that the effect of either form of suppression is to reduce the resonant frequency of the circuit. This is, however, of negligible importance, for the fact that ignition causes interference

over an enormous range of frequencies indicates that the shock excitation produced by the initial discharge is the major cause of interference.

A final direct effect of suppressors on the spark is to cause a retardation in timing, but calculation shows that this amounts to considerably less than one degree of camshaft rotation at the highest engine speeds, and consequently it may be entirely ignored.

## For Morse Practice

### SIMPLE VALVE OSCILLATOR

IT is difficult to find anything simpler than the Hartley circuit for an improvised audio-frequency oscillator for morse practice. A push-pull transformer, provided the centre-tapped winding has a high inductance value, can be adapted for the purpose; the writer uses a Sound Sales Type CT inter-valve transformer. As shown in the accompanying diagram, a two-cell torch battery provides the filament current and the HT.

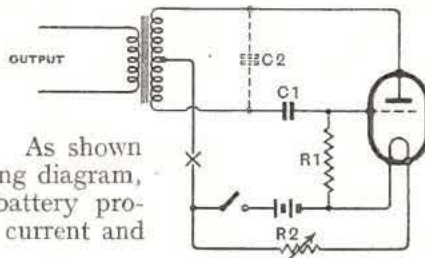

The note is initially controlled by the values of  $C_1$  and  $R_1$ . Values generally found to be satisfactory are  $C_1$  0.005 mfd. and  $R_1$ , 100,000 ohms. A further condenser  $C_2$  may sometimes be found desirable to improve the note, but only a small capacity should be used. It may sometimes be more convenient to use a larger capacity across the other winding.

With a valve requiring 2 volts at 0.1 amp. for the filament  $R_2$  should be 10 ohms. It is not necessary for it to be variable, since the valve continues to oscillate until the battery is down to about 2 volts, when the resistance may be shorted. However, a variable resist-

ance affords a useful control of tone, and by careful adjustment "cleans up" the note considerably. With a new battery, care should be taken not to overrun the valve.

The type of valve required is not very critical. A small power triode is probably the best, but the writer has obtained perfectly satisfactory results with a PM1LF.

In most cases the output is ample for headphones, but it can easily be increased by applying an extra few volts HT at X. This also provides a convenient point for keying, or keying may be applied in the output.

T. E. C.

## From the World's Technical Press

NEARLY one hundred and fifty of the world's technical journals are regularly searched, and the articles on wireless and allied subjects summarised, for inclusion each month in the Abstracts and References section of our sister journal *The Wireless Engineer*. This regular monthly feature, which for easy reference is arranged under fifteen headings, is compiled by the Radio Research Board, and published by arrangement with the Department of Scientific and Industrial Research.

Abstracts from, and references to, some four hundred articles are included in the March issue, which was published on the first of the month, and is obtainable through news-agents or direct from the Publishers, Dorset House, Stamford Street, London, S.E.1, at 2s. 8d. post free.

The March issue contains an article describing a "two-wire, four-wire" control terminal specially adapted for two-way radio-telephony. Another article deals with the ganging of superheterodyne receivers. A summary of recently accepted wireless patent specifications is included each month.

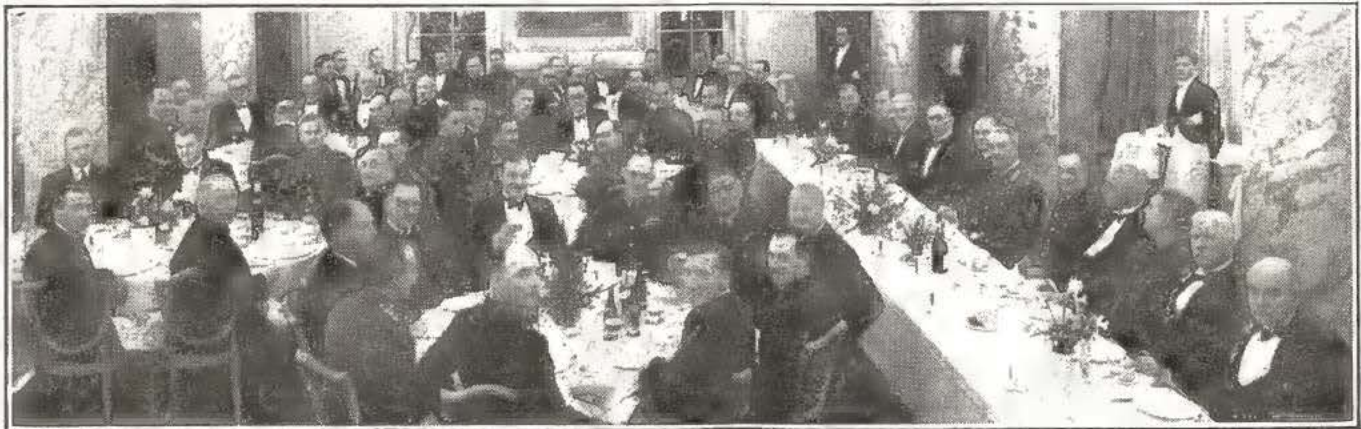

The 18th annual dinner of the British Wireless Dinner Club was held at the Waldorf Hotel on 17th February. Membership of the club is open to past and present wireless officers of the Services and civilian wireless personnel holding positions of responsibility. The picture includes only a part of the company. The attendance was fully up to the peacetime average.

# Unbiased

By FREE GRID

## Strange Incident

THOSE of you who carefully read my notes in the December issue of this journal will probably have had an inkling of the reason for my absence from the February issue of *The Wireless World*. I am pleased to be able to inform you that I have been enabled to fulfil the promise I made to you in the December issue, by entering the Fatherland through a neutral State. I had intended to tell you about it last month, but I reckoned without the stately and measured pace of the Censor's office.

Fortunately, as I have mentioned before, I received part of my education at a German university, and am quite familiar with the language and customs of the country. Nevertheless, I did not deem it advisable to pose as a German citizen returned to the fold from heathen lands afar. There are, however, still three German-speaking neutral countries and,



"A very august personage."

by posing as a native of one of these States—it would, of course, be most impolitic for me to disclose which one—I had no difficulty in getting across the frontier.

One of my first lines of investigation was to discover why it was that, in spite of the enormous volume of hot air emanating from German wireless stations, we had such an unusually cold January, which fact, since it is past history, I am now permitted to reveal in case you are unaware of it. I very soon discovered that, owing to the great coal shortage in Germany, there was such a tremendous home consumption of the aforementioned hot air that there

was none for export, with the result that we and our pipes had to suffer.

I have always been a believer in the old maxim that if a job is worth doing at all it is worth doing well, and consequently I did not enter Germany in any furtive manner or even humbly, as one asking a favour. On the contrary, I crossed the frontier with an entourage befitting a person of my importance, with the result that the frontier officials were duly impressed and vied with each other in their efforts to smooth my path instead of harassing me with pettifogging questions, as I noticed that they did to more humble folk of honest intent.

Boldness always pays, but I must confess that I hardly expected it to pay as well as it did in this case, for, when I detrained at the capital I was received by a guard of honour and a salute of nineteen guns, instead of by a squad of eight men and one volley, which might have been my fate.

My astonishment increased still further when I found myself inspecting the guard of honour in the company of a very august personage indeed. When a fat wad of genuine British banknotes was thrust into my hands, together with a word of sincere thanks for the good work I had done for the Fatherland among the wireless fraternity in England, my astonishment changed to bewilderment, and even now that I have had a chance to think the matter over at my leisure, I am still just as much in the dark as ever concerning the meaning of the incident. Can you enlighten me?

## An Unjust Accusation

I AM very pleased to see that winter is at last giving place to balmy spring. If it had persisted much longer I was seriously thinking of shifting my headquarters to the North Pole, where at least the keen east wind can never penetrate, and nothing but the soft south wind blows all the year round.

Talking of the North Pole reminds me that the note which I published

recently concerning the rigorous Arctic conditions which were being experienced by a reader who was shouldering his share of the war somewhere "north of ninety" seems to have brought upon my head a torrent of ignorant and ill-informed abuse. It is in fact alleged that the incident and also the photograph published with it will not "bear the



Where the soft south winds blow.

searching light of truth," as one reader puts it. The reason is that according to my critics the North Pole is exactly ninety degrees north of the Equator and since it is impossible to get further north than the Pole my statement is absurd.

This sort of criticism only shows, of course, how dangerous it is to attempt to draw conclusions from insufficient data, as not only is the statement that the reader was north of ninety perfectly true, but it is also straightforward, which is not always quite the same thing. Thus the best authorities tell me that it would be technically accurate to describe a man as being "north of ninety" if he were to cross the North Pole by air, but I should not like it to be thought that I would stoop to this subterfuge in order to bolster up the truth of my statement last month.

The true explanation is perfectly straightforward and simple. The mistake which every one of my critics made was to jump to the conclusion that the only Polar regions are those up north, forgetting the vast Antarctic continent and its surrounding seas, any spot on which (other than the South Pole itself) is north of ninety. So that's that.

# Tone Control in Hearing Aids

## RESPONSE TO SUIT INDIVIDUAL CASES

By T. S. LITTLER, M.Sc., Ph.D.

MUCH has been said in the past on the subject of prescribing hearing aids to accommodate a patient's individual hearing loss. It is important, however, that it should be made clear at the outset that, even if it were desirable, it is not generally possible to supply a hearing aid with a response approximating to a patient's threshold hearing loss if the average of that loss throughout the audible range is greater than 45 decibels. It is also important to realise that a threshold hearing curve as obtained by means of an audiometer gives only an idea of deafness to weak sounds. There is much evidence to show that in many cases deafness to loud sounds is not so severe as deafness to weak sounds, so that the ideal type of amplification for such subjects is one in which the amplification is reduced as the incident sounds become intense. For this reason a type of automatic gain control is incorporated in some hearing aids.

Our knowledge of the characteristics required to correct most efficiently for a given patient's hearing loss is still very scanty and much experimental work remains to be done on the subjective side to guide the instrument maker as to the characteristics required of him. As the matter stands, therefore, frequency response adjustment or tone control in a hearing aid is usually of a very simple type. Experimental evidence which has been obtained so far appears to indicate that with the present limits of hearing aid response extremely severe tone control is not only undesirable but it is a disadvantage. The writer is of opinion that even with a hearing aid of almost uniform response, tone control is only advisable to its full at weak intensities.

The simplest method of tone control is by means of a condenser, which when used in parallel with some resistance of the circuit reduces the impedance to high frequencies. Thus a small condenser across an anode resistance of a valve circuit will produce a response which decreases at high frequencies. On the other hand, a small inter-valve coupling condenser together with a grid resistance gives a response which decreases at low frequencies. In this case, the impedance of the condenser at the frequency

In last month's issue some of the general problems of hearing-aid design were discussed. The present article deals with methods of adjusting response characteristics to suit different kinds of deafness

at which reduction is required to commence must be of the order of the grid resistance it is associated with. When a screen grid valve is used in an amplifier, tone control can also be incorporated by varying the decoupling resistance in the screen circuit. For example, if the decoupling resistance in the two-valve differential aid previously described<sup>1</sup> is changed from 0.002 mfd. to 0.0005 mfd., the response at low frequencies below 500 cycles is reduced by a few decibels, the reduction being about 9 decibels at 200 cycles. If the condenser is increased to 0.01 mfd. the response at 200 cycles is increased by 7 decibels.

When a crystal microphone is used in a hearing aid it is equivalent to a condenser across the input of the first valve and the response at low frequencies is dependent on the size of the shunting resistance. The capacity of the microphone is of the order of 0.002 mfd. which is an impedance of about half a megohm at 200 cycles. It can be seen that by connecting a resistance of less than this value across the microphone the response at low frequencies can be reduced appreciably.

Examination of the table of effective amplifications shows that in order to get a characteristic which is either uniform or steadily rising to either end of the frequency range it is necessary to reduce the response in the middle of the range. At the present time this is not done in commercial hearing aids and the usual forms of tone control only result in level or gradually rising characteristics over a limited frequency range. In order to reduce the response in the middle of the range it is necessary to make use of a tuned circuit consisting of an inductance, resistance and condenser. There are two possible ways of incorporating such a filter, depending on whether it is to be used in parallel or in series with the circuit on which it is to operate. An example will show how the value of inductance, resistance and capacity can be determined. Consider a hearing aid with a peak response at 1,000 cycles in which one valve of the circuit has an impedance  $R_g = 25,000$  ohms and an anode resistance  $R_a = 50,000$  ohms. Suppose we wish to incorporate the tuned circuit across the anode resistance so that the response is reduced by ten

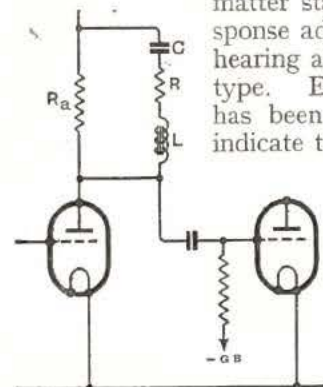

Fig. 1.—Filter circuit for reducing peaks in response at the middle of the speech range.

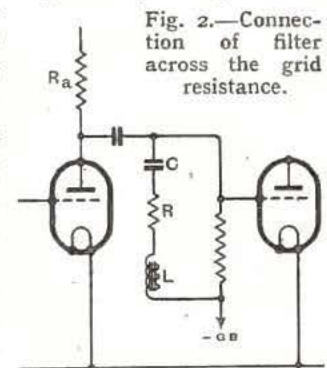

Fig. 2.—Connection of filter across the grid resistance.

<sup>1</sup> *The Wireless World*, January 19th, 1939.

### Tone Control in Hearing Aids—

decibels at 1,000 cycles but only by one decibel at 500 or 2,000 cycles. At the resonant frequency the effective resistance of the anode circuit must be reduced to about 6,500 ohms in order to reduce the voltage amplification

$$\mu \frac{R_a}{R_a + R_v}$$

about 3.2 times (i.e., 10 decibels). This means the total resistance  $R$  in the tuned circuit must be about 7,500 ohms. Since the circuit is in resonance at 1,000 cycles, we can assume, without serious error, that at 500 cycles the anode circuit is equivalent to 50,000 ohms shunted by the condenser  $C$  and resistance  $R$ . Its impedance becomes

$$\frac{R_a \sqrt{R^2 + \frac{1}{\omega^2 C^2}}}{\sqrt{(R_a + R)^2 + \frac{1}{\omega^2 C^2}}} \text{ ohms.}$$

For the amplification to be reduced by the factor 1.12 (i.e., about 1 decibel), this must become about 37,000 ohms or

$$\frac{\sqrt{(7,500)^2 + \frac{1}{\omega^2 C^2}}}{\sqrt{(50,000 + 7,500)^2 + \frac{1}{\omega^2 C^2}}} = 0.74.$$

This makes  $\frac{1}{\omega C} = 63,000$  ohms. Therefore  $C$  will be 0.005 mfd., giving  $L$  a value of 5 henrys. Fig. 1 gives the appropriate valve stage circuit.

The effect of a filter of this type on the acoustic response of a hearing aid is to reduce the peak in the middle of the range, although the overall response is still by no means uniform. It is now possible to add a further valve stage to the amplifier so modified and to increase the amplification by about 10 decibels overall. This results in an amplification which is unobtainable by other means except by the use of a better microphone and moving coil telephone. On top of such a modified response it is now possible to incorporate simple filter systems giving gradual decrease of response to either end of the speech range.

An interesting modification of the filter system described above is obtained by connecting it, as shown in Fig. 2, across the grid resistance instead of across the anode resistance. In this way the band of frequencies over which reduction takes place is broadened out, and at low frequencies the coupling condenser forms a potentiometer with the filter condenser and the low frequencies are reduced in a known ratio. For example, if a 5-henry choke with a tuning condenser of 0.005 mfd. is placed across a grid leak and resistance, and the coupling condenser is 0.005 mfd., the reduction in sensitivity occurs over a broader band of frequencies, and at all low frequencies the response is reduced by six decibels. The peak reducing circuit can also be connected across the output telephone, but the amount of control obtainable is not so great as in the method described above.

One other method of altering the response of a hear-

ing aid, worthy of notice because of its simplicity, is adjustment by tuning of the telephone or microphone diaphragm. By alterations in the weight and physical characteristics of the diaphragm of the telephone receiver the first resonance peak can be varied over a certain frequency range, but this method is not a very satisfactory one with moving iron telephones of the type generally used.

In the case of the microphone of a hearing aid a resonance of the diaphragm occurring near the middle of the speech range is undesirable, although it is made use of in some carbon and crystal microphones to obtain maximum sensitivity. Such a resonance is followed by a series of secondary peaks and troughs in the microphone response. This fact can be demonstrated when the response of a hearing aid is measured over a continuous frequency range instead of at a number of fixed frequencies. The assembly of the piezo-electric telephones can be tuned effectively to much higher frequencies than moving-iron telephones, and the change over from moving-iron to piezo-electric telephones in raising the response of an aid in the region 2,000 to 4,000 cycles per second by about 10 decibels can be used as a form of tone control.

Obviously, it is not possible, by means of filter systems, to increase the response of a hearing aid over any region, as the nature of a filter is to reduce the response over the region least wanted. There is, however, the possibility of incorporating a positive feedback circuit which may be tuned if desired to increase the response over a certain band. Whatever is done, however, it can be seen that any attempt at matching to a deaf patient's hearing curve can only be approximate, unless by chance the patient's hearing curve is of the same type as the response of the aid.

## BOOKS ON WIRELESS

Issued in conjunction with "The Wireless World"

	Net Price	By Post
"FOUNDATIONS OF WIRELESS," by A. L. M. Sowerby. Second Edition ...	5/-	5/5
"RADIO LABORATORY HANDBOOK," by M. G. Scroggie ...	8/6	9/-
"WIRELESS SERVICING MANUAL," by W. T. Cocking. Fourth Edition ...	5/-	5/5
"HANDBOOK OF TECHNICAL INSTRUCTION FOR WIRELESS TELEGRAPHISTS," by H. M. Dowsett. Sixth Edition ...	21/-	21/9
"WIRELESS DIRECTION FINDING," by R. Keen. Third Edition ...	25/-	25/9
"RADIO DATA CHARTS," by R. T. Beatty. Second Edition ...	4/6	4/10
"ELEMENTARY PRINCIPLES OF WIRELESS TELEGRAPHY AND TELEPHONY," by R. D. Bangay. Revised by O. F. Brown. Third Edition ...	7/6	8/-
"THE WIRELESS WORLD" DIARY FOR 1940 ...	1/6	1/7
"LEARNING MORSE" ...	6d.	7d.

Obtainable from Leading Booksellers and Railway Bookstalls or by post (remittance with order) from

**LIFFE & SONS LTD., Dorset House, Stamford Street, London, S.E.1**

# Single-Valve Sets

## NEW LIGHT ON OLD CIRCUITS

FIFTEEN years or so ago the single-valve receiver was by no means uncommon, but it is now extremely rare. It was used largely because valves were expensive and fragile, and it has been displaced partly because they are now relatively cheap and robust, but more because the loud speaker has superseded phones. With rare exceptions a single-valve set is unsuitable for operating a loud speaker.

The chief merits of a one-valve set are its compactness and low cost, and so it is worth while considering for emergency use in wartime. It is eminently suited to battery operation, but hardly worth while for mains drive, since the cost of the mains equipment would form a large proportion of the total.

It might be thought that there would be little scope for the choice of circuit with only one valve, but actually there are very many different ways of connecting it. The most economical and at the same time the most generally useful circuit is that of a straightforward reacting grid detector. This arrangement is shown in Fig. 1, and it is suggested that one of the new 1.4-volt valves, such as the 1E4G, would be especially convenient, since it permits the use of a single dry cell for LT.

The values of certain components are best chosen experimentally to suit the particular valve used. Sensitivity depends very largely upon the attainment of perfectly smooth reaction which is quite free from backlash. Nearly all components exercise an effect on this, but it is largely controlled by the grid potential. In general, the higher the value of the grid leak and the less positive the point to which it is returned, the smoother is reaction. On the other hand, if the grid leak is not taken to a point sufficiently positive, detector efficiency suffers.

As a start, values of 2 MΩ for R1 and R2 will give good results. If reaction is at all ploppy, reduce R1 and/or increase R2, thus moving the effective point of return towards negative LT. A reduction in HT voltage also helps towards the attainment of smooth reaction.

The value of R3 should also be determined experimentally, but it is rarely at all critical and can usually be about 5,000 ohms. Too large a value will reduce signal strength, while too small a value will make it difficult to secure proper reaction effects.

The choice of tuning components depends on the wavelengths to be covered. For medium and long waves C1 should be 0.0005 μF and C4 can be 0.002 μF

to 0.0005 μF, the larger value being preferable. For medium waves, L2 can consist of 58 turns of No. 24.DCC close wound on a 2½ in. diameter former. The reaction winding L3 can be wound at the earthy end with a thinner wire such as No. 36. The turns needed depend on C4, but about 20 will make a good start. Choose the turns experimentally so that the valve starts to oscillate with C4 about half-way in. The primary L1 should be overwound on L2 at the earthy end. No. 36 wire can be used and wound in the grooves between the wire of L2. About 10-15 turns will be

needed with an average aerial.

On short waves C1 should be smaller; 50 micro-microfarads is a good size above 15 metres, but below this it should not exceed about 70 micro-microfarads. On ultra-short waves a much smaller capacity is advisable; it is, however, doubtful whether this particular arrangement would be much use below about 10 metres. It would certainly be useless to any but a

skilled operator on account of the extreme sharpness of tuning on anything but very strong signals.

On all wavebands a good variable condenser with a good slow-motion drive which is quite free from backlash is essential; with critical reaction tuning is sharp on weak signals. The condenser C4 should be mounted some distance from the panel and operated by an insulating control shaft in order to avoid hand capacity effects.

With careful handling and a good outdoor aerial the sensitivity of a receiver of this type is surprisingly high. Some years ago the writer regularly received Australian broadcasting on 30 metres with a set of this type. Admittedly, the signals were weak, but they were intelligible. No difficulty should be found in receiving American SW stations under average conditions.

### An Inherent Weakness

Where a receiver of this type fails is in selectivity. On medium and long waves the stronger stations usually spread too much to permit good reception of the weak ones, and this difficulty also occurs in some degree, but much less, on short waves.

The selectivity can, of course, be increased by using an additional tuned circuit, so that there are two tuned circuits on the lines of a band-pass filter before the valve. This entails a loss of signal strength of at least 50 per

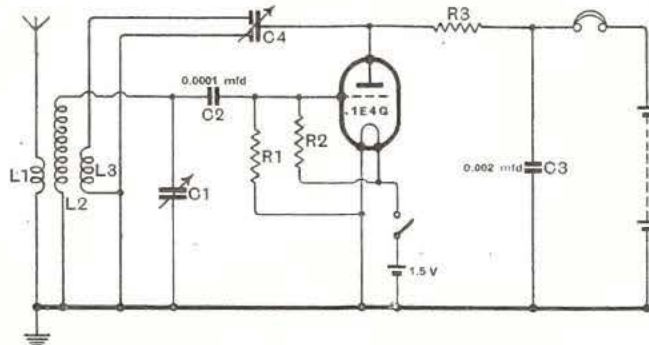

Fig. 1.—A reacting detector circuit provides more sensitivity than any other single-valve arrangement. The finer points of smooth reaction control, on which its performance so largely depends, have been discussed in recent issues.

## Single-valve Sets—

cent., and the improvement in selectivity is not very evident on channels very close to the wanted one. This system, however, is very effective in reducing interference from a station several channels away.

The two tuned circuits must be quite loosely coupled if reaction is to function well and for the best results separately tuned circuits with adjustable coupling are desirable. With this system surprisingly good results

are reduced in value the radio-frequency performance suffers, and, worse still, all sorts of unwanted feed-back effects are likely to occur. Design is essentially a difficult compromise between conflicting factors.

Amplitude distortion is not unlikely because the valve has to handle both RF and AF signals. This is not a serious factor when one of them is very small, as is usually the case, but there is inevitably a compromise in the choice of the valve. The best valve for RF

amplification is often not the best for AF, and vice versa. To overcome this in some degree, the AF output is sometimes taken from the screen instead of the anode. The valve then functions as a pentode RF amplifier and a triode AF amplifier.

Much more true amplification can be obtained from the reflex circuit than from the reacting detector of Fig. 1. In general, however, reaction cannot be used with it so well, and the gain is lower than that of the reacting detector with reaction pushed to the verge of oscillation. For the reception of moderately strong signals the reflex circuit with a *little* regeneration may well prove better than the reacting detector, and can be made easier to handle. For very weak signals, however, there is little doubt that the circuit of Fig. 1 is the better if properly handled.

The circuit of Fig. 2 is not difficult to get working, but serious troubles are often encountered if an attempt is made to precede it by another valve as an RF stage or to follow it by an AF amplifier. Such additions are by no means impossible, but feed-back sometimes assumes serious proportions.

Lastly, the possibilities of the crystal and AF stage

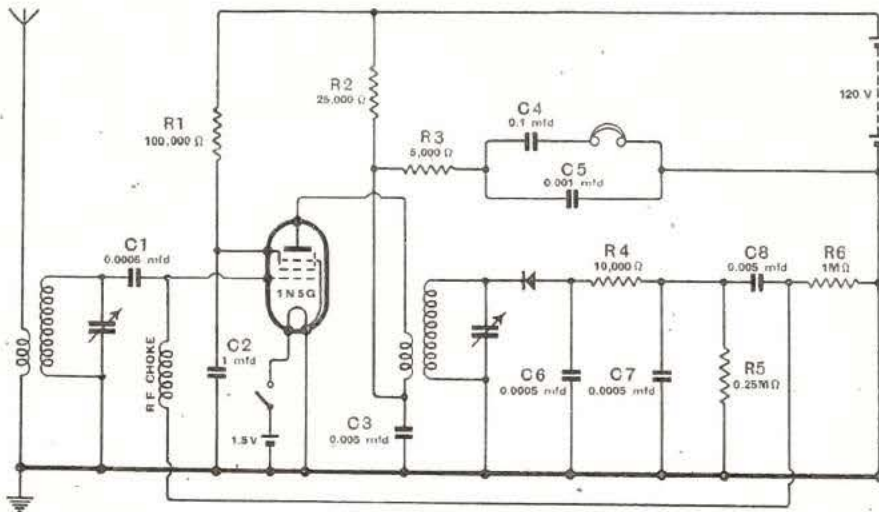

Fig. 2.—The single-valve reflex circuit can be brought up to date by proper RF/AF filtering and the use of a Westector in place of the unreliable crystal.

can be obtained in the hands of a skilled operator. Skill is essential, for there are four interdependent controls.

Circuits of this nature were widely used at one time, but have been superseded by multi-valve sets because these are much easier to handle and give a much better performance. Their only disadvantage is that they are more expensive and use more battery power.

## One Valve: Two Jobs

In an endeavour to obtain a multi-valve performance with only one valve, the reflex circuit was introduced and became very popular. A circuit of this type using the 1N5G valve is shown in Fig. 2. The RF signal is applied to the grid through C1. The anode circuit is conventional to radio-frequency for R2 and C2 act as decoupling components. A crystal or Westector is used for the detector and fed from the second tuned circuit. The detector output is well filtered by R4 and C7, and the output is taken through C8 and applied to the grid of the valve through an RF choke. In the anode circuit R2 acts as a coupling resistance, and the AF currents are fed to the phones through the filter R2 C5. The valve thus acts simultaneously as an RF amplifier and as an AF amplifier.

Considerable care is needed for satisfactory results, and the quality usually suffers somewhat. The most obvious trouble is a falling off in the high-frequency response. C7 and C1 are effectively in parallel at radio-frequency and shunt R5, while in the anode circuit both C3 and C5 reduce the upper register. If these capacities

Fig. 3.—Single-valve loud speaker set; one of the new low-input copper oxide rectifiers is, as in the case of Fig. 2, particularly suitable as a detector.

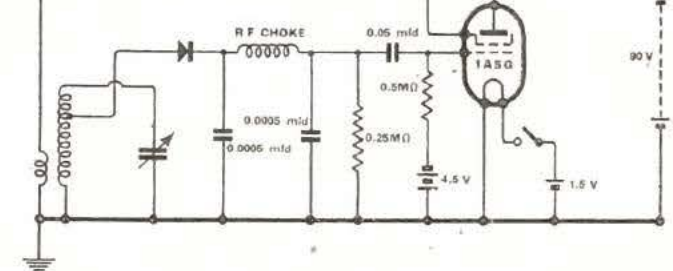

should be considered. This arrangement is sometimes useful; as with a strong signal it can operate a loud speaker. As shown in Fig. 3, a 1A5G valve can be used with a 90-volt HT supply and 4.5 volts grid bias. It will consume only 4.8 mA, and give an output of about 115 mW into a load of 25,000 ohms. It is only useful when a strong signal can be obtained; say, up to 7 miles from a broadcasting station, with a good outdoor aerial.



# NEWS IN ENGLISH FROM ABROAD

## REGULAR SHORT-WAVE TRANSMISSIONS

Country : Station	Mc/s	Metres	Daily Bulletins (B.S.T.)	Country : Station	Mc/s	Metres	Daily Bulletins (B.S.T.)
<b>America</b>				<b>Hungary</b>			
WNBI (Bound Brook) ..	17.78	16.87	6.0	HAT4 (Budapest) ..	9.12	32.88	12.30 a.m.†, 1.30 a.m.
WCBX (Wayne) ..	6.12	49.02	7.55 a.m.	HAS3 .. ..	15.37	19.52	2.55†.
WCBX .. ..	9.65	31.09	5.0 a.m.	<b>Ireland</b>			
WCBX .. ..	11.83	25.36	12.30 a.m.‡, 12.45 a.m.†, 2.55 a.m., 11.50§†.	Athlone .. ..	9.39	31.28	6.45, 10.0 (10.5 Sun.).
WCBX .. ..	15.27	19.65	7.30§.		17.84	16.82	6.45, 10.0 (10.5 Sun.).
WCBX .. ..	17.83	16.83	2.0, 3.0†, 5.0†.	<b>Italy</b>			
WGEO (Schenectady) ..	9.53	31.48	12.25 a.m., 9.30†, 10.55§†, 11.15†.	I2RO3 (Rome) ..	9.63	31.15	4.0 a.m., 7.35 a.m., 7.28, 10.15.
WGEO (Schenectady) ..	9.55	31.41	12.15 a.m.	I2RO9 .. ..	9.67	31.02	12.30 a.m.
WGEO .. ..	15.33	19.57	2.0, 10.55§†.	I2RO4 .. ..	11.81	25.40	4.0 a.m., 4.45, 8.25.
WGEO .. ..	21.50	13.95	9.30.	I2RO6 .. ..	15.30	19.61	4.0 a.m., 7.35 a.m., 12.15, 8.25.
WPIT (Pittsburgh) ..	6.14	48.86	4.0 a.m.‡, 5.0 a.m.‡, 5.30 a.m.†.	I2RO8 .. ..	17.82	16.84	12.15, 4.45.
WPIT .. ..	11.87	25.27	12.45 a.m.†.	<b>Japan</b>			
WRUL (Boston) ..	6.04	49.67	12.0 midnight.	JVW (Tokio) ..	7.25	41.34	9.5.
WRUL .. ..	11.79	25.45	9.30§†.	JZI .. ..	9.53	31.48	9.5.
WLVO (Cincinnati) ..	6.06	49.50	7.25 a.m., 12.0 midnight†.	<b>Manchukuo</b>			
<b>Australia</b>				MTCY (Hsinking)	11.77	25.49	3.50, 7.30, 10.0.
VLQ (Sydney) ..	9.61	31.22	9.15 a.m.	<b>Rumania</b>			
VLQ2 .. ..	11.87	25.27	9.15 a.m.	Bucharest ..	9.28	32.33	10.55†.
VLR (Melbourne) ..	9.58	31.32	10.0 a.m., 2.50.	<b>Russia</b>			
VLR3 .. ..	11.88	25.25	9.50.	RNE (Moscow) ..	6.00	50.00	11.0.
<b>China</b>				RW96 .. ..	6.03	49.75	1.0 a.m., 9.0, 10.30.
XGOY (Chungking) ..	11.90	25.21	12.10, 11.0.	RWG .. ..	7.36	40.76	10.30.
<b>Finland</b>				RKI .. ..	7.52	39.89	10.30.
OFD (Lahti) ..	6.12	49.02	12.40 a.m., 7.20, 9.40, 10.30.	— .. ..	8.07	37.17	9.0, 10.30.
OFD .. ..	9.50	31.58	12.40 a.m., 2.15 a.m., 7.20, 10.30.	— .. ..	9.53	31.48	11.0.
<b>OIE</b> .. ..	15.19	19.75	12.40 a.m., 7.20, 10.30.	RAL .. ..	9.60	31.25	1.0 a.m., 9.0, 10.30.
<b>France</b>				RW96 .. ..	9.68	30.99	9.0.
— (Paris-Mondial) ..	9.52	31.51	2.0 a.m., 4.30 a.m., 6.15 a.m.	— .. ..	11.64	25.77	11.0 a.m.
TPA4 .. ..	9.68	30.99	9.15 a.m., 8.30.	— .. ..	11.90	25.21	11.0 a.m.
TPA4 .. ..	11.72	25.60	2.0 a.m., 4.30 a.m., 6.15 a.m.	RNE .. ..	12.00	25.00	1.0 a.m., 4.0†.
TPA3 .. ..	11.88	25.25	2.0 a.m., 4.30 a.m., 6.15 a.m., 9.15 a.m., 8.30.	RKI .. ..	15.04	19.95	1.0 a.m.
TPC3 .. ..	17.77	16.88	12.0 noon.	RW96 .. ..	15.18	19.76	8.0 a.m.
<b>French Indo-China</b>				<b>Spain</b>			
F2R (Saigon) ..	11.78	25.47	12.0 noon, 4.30.	FET1 (Valladolid) ..	7.07	42.43	8.45.
<b>Germany</b>				EAJ7 (Madrid) ..	9.86	30.43	4.25.
DJC (Zeessen) ..	6.02	49.83	8.0.	<b>Sweden</b>			
DXM .. ..	7.27	41.27	12.15 a.m.	SBO (Motala) ..	6.06	49.50	10.45.
DJI .. ..	7.29	41.15	11.15.	SBU .. ..	9.53	31.48	10.45.
DJA .. ..	9.56	31.38	7.15.	SBT .. ..	15.15	19.80	7.15.
DXB .. ..	9.61	31.22	8.15, 9.15.	<b>Turkey</b>			
DJB .. ..	15.20	19.74	10.15 a.m., 2.15., 5.15.	TAP (Ankara) ..	9.46	31.70	8.15.
OLR5A (Podébrady) ..	15.23	19.70	8.50.	TAQ .. ..	15.20	19.74	1.15.
				<b>Yugoslavia</b>			
				YUC (Belgrade) ..	9.50	31.58	10.30.

The times of the transmission of news in English from the B.B.C. short-wave station are given in Current Topics, page 216.

## REGULAR LONG- AND MEDIUM-WAVE TRANSMISSIONS

Country : Station	kc/s	Metres	Daily Bulletins (B.S.T.)	Country : Station	kc/s	Metres	Daily Bulletins (B.S.T.)
<b>Estonia</b>				<b>Italy</b>			
Tartu .. ..	731	410.4	10.5.	Rome 1 .. ..	713	420.8	12.30 a.m., 7.28, 10.15.
<b>Finland</b>				Milan 1 .. ..	814	368.6	12.30 a.m., 7.28.
Lahti 1 .. ..	166	1,807	12.40 a.m., 9.40., 10.30.	<b>Latvia</b>			
<b>France</b>				Madona .. ..	583	514.6	10.0 (Tues. and Fri.):
Radio-Paris .. ..	182	1,648	9.30.	Kuldiga .. ..	1,104	271.7	10.0 (Tues. and Fri.).
<b>Germany</b>				<b>Rumania</b>			
Bremen .. ..	758	395.8	12.15 a.m., 10.15 a.m., 2.15, 5.15, 7.15, 8.15, 9.15, 11.15.	Radio-Romania ..	160	1,875	10.55†.
Hamburg .. ..	904	331.0	12.15 a.m., 10.15 a.m., 2.15, 5.15, 8.15, 9.15, 11.15.	Bucharest .. ..	823	364.5	10.55†.
<b>Hungary</b>				<b>Russia</b>			
Budapest 1 .. ..	546	549.5	11.10.	Moscow 1 .. ..	172	1,744	11.0.
Kassa .. ..	1,158	259.1	11.10.	<b>Sweden</b>			
<b>Ireland</b>				Motala .. ..	216	1,389	7.15, 10.45†.
Radio-Eireann ..	565	531	6.45†, 10.0 (10.5 Sun.).	Stockholm .. ..	704	426.1	10.45†.
				Hörby .. ..	1,131	265.3	7.15, 10.45†.

All times are p.m. unless otherwise stated. \* Saturdays only § Saturdays excepted. † Sundays only. ‡ Sundays excepted.

# Getting the Best from Records

## Part III.—MORE ABOUT TONE CORRECTION CIRCUITS

By P. G. A. H. VOIGT, B.Sc., A.M.I.E.E.

In the previous instalment simple methods of tone control for piezo pick-ups were discussed, and in this article the treatment is extended to moving iron pick-ups. An easily constructed resistance-capacity bass and treble control circuit is also described

**M**OVING iron pick-ups have what is basically a constant-velocity characteristic. Gramophone records are, however, necessarily recorded with a rising characteristic. There is therefore with moving iron pick-ups a natural tendency for an excess of treble and a shortage of bass. As a top resonance usually aggravates the trouble it is particularly disastrous, and for quality reproduction should either be made innocuous or corrected for. Of these alternatives, the second does not involve alterations to the pick-up itself, and we will therefore concentrate on it.

By far the best way of testing for pick-up resonances and adjusting their correction circuits is with a calibrated test record and output meter. For the record I prefer a gliding tone record<sup>1</sup> since with fixed note records the work of taking a curve is rather laborious, and is liable to be inaccurate especially if a peak or trough occurs in between two notes.

For those who have no proper output meter handy, a very simple "programme meter" can be improvised if a milliammeter of suitable range and a resistance-coupled amplifier are available.

An adapter is required (home made will do) such as that shown in Fig. 13(a). This enables a meter to be inserted in the anode lead of the last valve with an anode resistance, and a small mica condenser of, say, 0.0003 mfd. to be connected in its grid lead. Doing

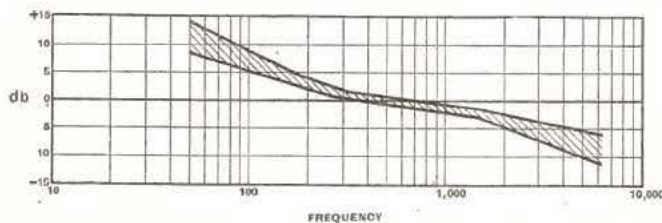

Fig. 12.—Estimated limits of overall pick-up and amplifier characteristics required for the reproduction of modern recordings. The derivation of this curve was discussed in Part I in the February issue.

this gives the circuit of Fig. 13(b), and it will be seen that the "official" grid bias of the valve now has no means of reaching the grid. As a result, the anode

current will rise to an amount limited by the anode resistance. When an AF voltage arrives, however, grid current will flow as in an ordinary RF grid detector, and this provides a bias equal to the peak value of the incoming signal. The anode current drops, and the reduction in anode current (with a slight zero error) is a measure of the signal on the grid. When the signal stops, the grid recovers its "no signal" voltage slowly at a speed depending upon general leakages. (Note that with an input large enough to depress the anode current below half the "no signal" value, bottom bending occurs and upsets the linearity. Readings be-

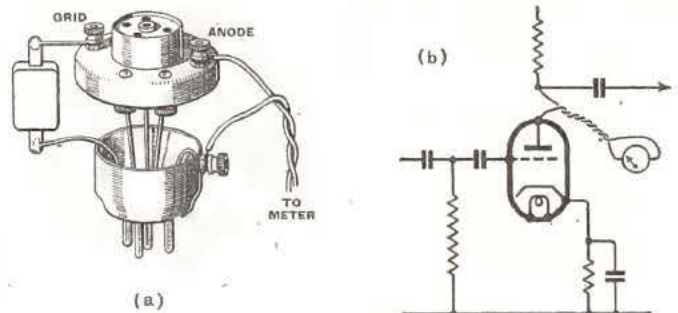

Fig. 13.—Improvised output valve voltmeter and its equivalent circuit. The filament and cathode terminals may be inverted for convenience.

low half the "no signal" value should therefore be ignored as unreliable.)<sup>2</sup>

### Preliminary Tests

Having improvised this test circuit, and checked that there is enough signal to operate the meter by playing an ordinary record, play over the heterodyne record while watching the meter. Fig. 14 illustrates the kind of result to be expected with a normal moving iron pick-up and it is as follows:—

Starting at a high frequency such as 8,500 cycles the deflection is very small. As the frequency goes down the scale, the pick-up seems to go into action more or less suddenly, and the meter needle moves well away from the "no signal" position, the point of maximum movement indicating the position of the main treble peak. As the frequency drops below resonance, the deflection falls to a lower value which is maintained more or less down the scale until that frequency is reached where the velocity is cut down on the heterodyne record. Below this point, it drops smoothly except for a possible torsional resonance and for the main tone arm

<sup>2</sup> Information giving curves with various valves was given by the writer in the course of a discussion. See I.E.E. Journal, 1932, Vol. 71, p. 632.

<sup>1</sup> H.M.V. DB 4037 is suitable.

## Getting the Best from Records—

resonance which lifts the bass and then cuts off. When torsional tone arm resonance occurs, it may take the form of the irregularity shown by the dotted line.

If it is necessary to refer back to a curve later, the memory is unreliable, and it is then best to plot the

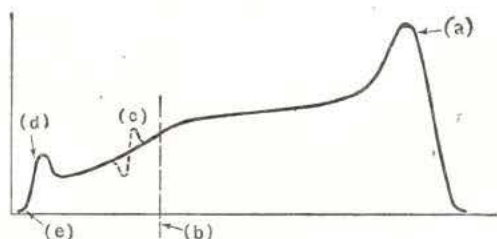

Fig. 14.—Typical response characteristic of a moving iron pick-up. (a) Main treble resonance, (b) frequency below which record cuts base, (c) torsional tone arm resonance, (d) main tone arm resonance, (e) bass cut-off.

curve and write on the paper immediately all the information (including date) which might prove useful several years later. Vast amounts of experimental work have to be repeated because the curves taken cannot be identified when required on a subsequent occasion.

A simple way of plotting the curve is to get a friend to act as metronome and call out every 5 seconds or so. You can then watch the meter, and the readings taken at regular intervals can be written down and plotted. Near critical resonant points, etc., a 5-second interval may be too great; if, however, time and height of the peak be noted, then the most important factor is established.

In the case of pick-ups using normal needles, needle holders, etc., the main top resonance usually occurs around the 2,500-3,000 cycle region. The ideal treatment, of course, is to damp the resonance and also to drive it upwards. As the armature forms part of the vibrating masses, and any reduction in mass makes the resonant frequency rise, one possibility for the designer is to dispense with the armature altogether and make the needle serve the double purpose. This no doubt is what gave rise to the needle armature pick-up, in which with normal needles the resonance went up to the 4,000-5,000 cycle region. Unfortunately even this is not high enough to make the resonance innocuous, and if the construction of the pick-up is not such as to damp out this resonance then a correction circuit to remove the resulting peak will still be desirable.

One of the simplest ways of correcting for a treble resonance is by a simple absorption circuit as shown in Fig. 15. The values of the components required will, of course, depend upon the individual characteristic of the pick-up in use. For example,  $R = 2,000$  ohms,  $L = 0.14$  H and  $C = 0.02$  mfd. were found suitable for the moving iron pick-ups in general use a few years ago and whose resonant frequency occurred just below 3,000 cycles. (Note the inductance can be home made and consist of about 2,000 turns of thin wire, say, 36 s.w.g. on a former  $1\frac{1}{2}$  in. diam.,  $1\frac{1}{4}$  in. long,

wound with the aid of a hand drill held in a vice. The winding depth will be about  $\frac{1}{8}$  in.)

Let us assume that we are dealing with a pick-up which had been found by calibration to have a top peak in the same region and whose masses seem normal. As a first shot we can try the values given. Suppose that the result with the corrector is not quite right, and that it is effective either too high or too low down the frequency scale. This can be adjusted either by altering the capacity or the inductance. To make it operate half an octave lower down would require either twice the capacity or twice the inductance or  $\sqrt{2}$  times the capacity plus  $\sqrt{2}$  times the inductance. When the corrector has been adjusted for frequency, let us suppose it is too narrow in action, i.e., it leaves the sides of the original peak standing up. It is then necessary to alter the L/C ratio, while keeping the product, LC, constant. To broaden an absorber, decrease L and increase C. (With a rejector it is the other way about, and L must be increased and C reduced.)

Suppose now that the corrector has been adjusted for frequency and spread, but is either too effective, so that it causes a trough, or not effective enough. When this happens, R must be altered, an increase in losses causing a reduction in effectiveness and vice versa.

We have thus a very simple method of compensating for the effect which the main treble peak has on both the response, and the surface noise. As far as overall characteristic is concerned there still remains the problem of obtaining the general slope which the rising recording characteristic necessities: A simple rough-and-ready way of obtaining a slope is to use an amplifier fitted with means for adjusting the frequency response in a general way.

In 1933 the writer designed an adjustable corrector to the order of a well-known enthusiast. This used multi-stud switches for controlling treble and bass independently, one advantage of switches being that adjustment is by definite steps and so save continuous minute adjustment. Since then details of several switch

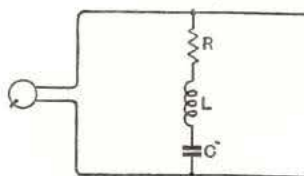
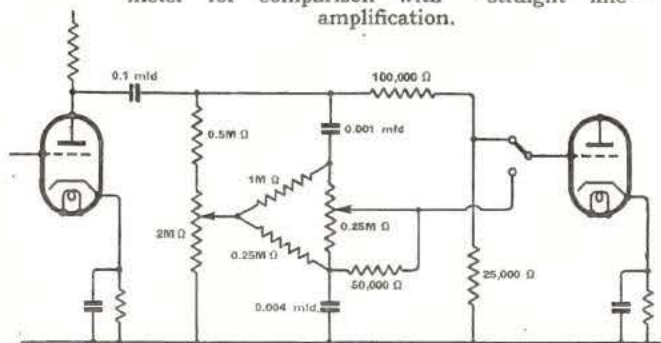

Fig. 15.—Simple absorption circuit for correcting the pick-up resonance in the treble.

Fig. 16.—Independent bass and treble control circuit with switch to change over to fixed potentiometer for comparison with "straight line" amplification.



type-circuits on generally similar lines have been published from time to time. More recently, the writer has developed the continuously variable circuit shown in Fig. 16 which while serving the same purpose is much

## Getting the Best from Records—

simpler to construct. With it, a loss of gain to about 1/5th is experienced. To facilitate comparisons with "straight line" amplification, without having to upset the tone control settings a 5 : 1 potentiometer and a switch can be provided so as to switch from the adjustable control to the fixed potentiometer. A third posi-

Fig. 17.—(a) Intervalve circuit giving maximum bass lift required by constant velocity pick-up on average recordings. (b) Form of response curve obtained.

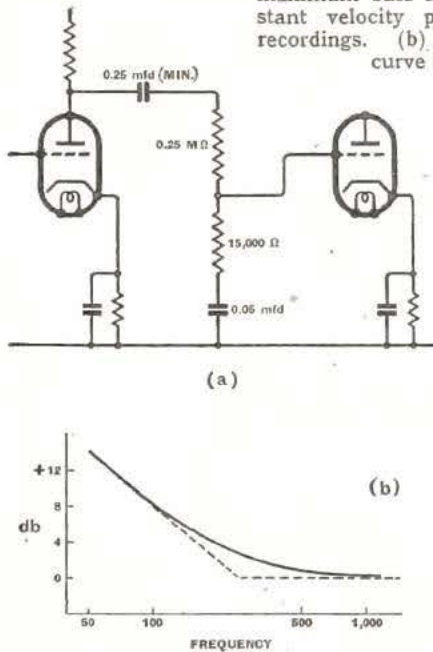

tion permitting full gain is a useful addition.

If such a circuit is used to compensate permanently for the recording, it will normally be in a bass lifting and top reducing position. As, however, the setting is liable to be altered whenever the amplifier is used for other purposes, a permanent circuit adjusted to

give the same effect connected between the pick-up and amplifier is greatly to be preferred. A circuit of the same type, but with values to suit the pick-up impedance could be built. As, however, it would be permanently set, an even simpler bass-lifting circuit following the pick-up, and designed to give the general slope, could be used. In addition, if sufficient gain is available an adjustable corrector as described could then be used for its legitimate purpose, i.e., to correct for poor records, defective transmissions, etc.

## Designing "Bass Lift" Circuits

Bass lifting is really a misnomer, as middle and top depression is what really happens. There is, therefore, with such circuits always a considerable loss of gain. Fundamentally a simple bass lifting circuit is a potentiometer for cutting down the voltage of middle and treble frequencies, but with a condenser connected in series with the bottom section so as to prevent the potentiometer becoming effective at low frequencies. The resistance ratio determines the amount of high-frequency reduction according to the usual rules, while the size of the capacity can be worked out from the fact that very roughly there is a 6 db lift at the frequency where the reactance of the condenser is 1.7 times the resistance of the lower limb of the potentiometer.

Fig. 17 shows an intervalve circuit on these lines together with its characteristic curve. This particular circuit gives very nearly the bass lift which a constant

velocity pick-up would require if the generally held beliefs regarding recording characteristics were correct. Using the values shown the loss of gain for middle and high frequencies is 17 times. At 32 cycles, however, about half the available voltage is passed on, while for lower frequencies still, the proportion becomes greater and greater if the coupling condenser is large enough.

A simple bass lifting circuit of this type is shown in Fig. 18 (a) added to the peak absorption circuit. If the values of the resistances which make up the potentiometer are too low, they act as a resistive load on the pick-up at high frequencies which are then attenuated somewhat owing to the pick-up inductance.

## Restoring the Treble

In practice, if there is a loss of extreme top (from whatever cause), a condenser through which these frequencies pass easily—added as shown in Fig. 18 (b)—will restore some of the top. This helps especially in the region above the top resonance, and may therefore improve the overall effect materially. An extra resistance as shown at X at Fig. 18 (b) is sometimes necessary if the bottom resistance is spoiling the effect of the top restoring condenser.

Thus, by juggling with two resistances and two condensers we can:—

- Depress middle and treble relative to bass by potentiometer action.
- Adjust the frequency at which bass lifting becomes effective.
- Depress extreme treble further by throwing a resistive load on the inductance of the pick-up.
- Lift extreme treble if required.

When calibrating the final overall curve, a straight line should not be obtained, as no heterodyne record is truly representative of the overall rising recording characteristic.

To convert the meter deflection into decibels is easy if it is remembered that a 2 : 1 voltage change is approximately equal to a 6 db difference. The correction for the record should then be added if the final amount is required on a db basis. Alternatively the voltage ob-

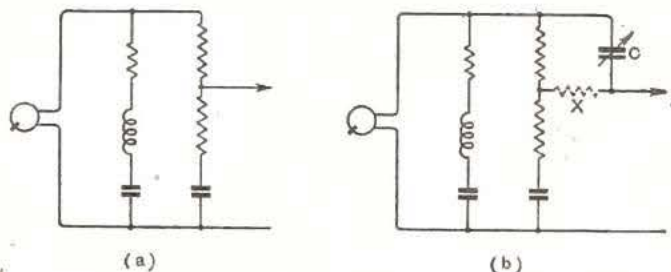

Fig. 18.—(a) Simple treble peak absorption and bass lifting circuits applied to the pick-up. (b) The addition of a condenser C and possibly a resistance X may be necessary to restore general loss of top.

tained can be directly compared with Fig. 19, which has been worked out from Fig. 12 and corrected for heterodyne record H.M.V. D.B. 4037.

The needle stiffness is the primary factor in determining the top resonant frequency, a tuned corrector

Getting the Best from Records—

adjusted for one type of needle will therefore not be correct with a needle of different strength. This applies particularly when comparing stiff steel needles with the much softer "fibre" or "thorn" needles so popular with gramophone lovers. With these materials the point is soft and is supposed to give way rather than wear out the record, a point of great importance when expensive records are in use. Furthermore, these needles seem to be somewhat self-damping, the treble peak is therefore not so fierce as with steel needles. This robs scratch of its "bite," making it much less noticeable, while the rapid cut off which occurs above resonance helps further to reduce the scratch. They have the double advantage of behaving as a very inexpensive scratch filter, and being very "kind" to the records.

On the debit side there are two factors which become more serious the better the reproducing gear. First, the point often "goes" before the end of the record, and secondly needle stiffness is not constant. It varies from needle to needle and with individual needles increases as successive sharpening reduces their length. This makes it impossible for a fixed tuned corrector to be as accurate as is possible when only needles of constant stiffness are used.

Fortunately the self damping of these special needles prevents the peak from being very sharp, the required absorption is therefore neither critical nor deep; consequently great accuracy becomes less important. The best thing when adjusting a tuned corrector for these needles, is to set it for a needle slightly shorter than when new. A new needle will then not be far wrong, while a short needle can be made to behave as though it were longer by not having it right back in the holder.

If difficulty in calibrating is experienced owing to the point becoming blunt in the 8,000 cycle part, it may be necessary to start at a lower frequency on the record. Even if no attempt is made to correct for resonance when using "fibres," the methods already described for lifting bass and restoring top are applicable and usually very helpful.

The trend of modern pick-up design is to drive the main treble peak upwards as far as possible. This is undoubtedly desirable especially as this result is obtained largely by a reduction of masses. Less mass also means that the record groove need only exert smaller accelerat-

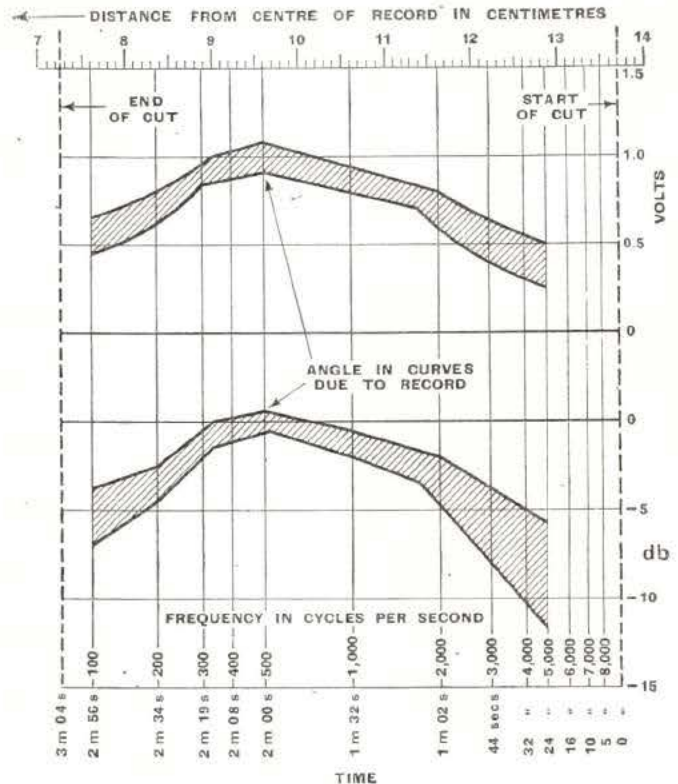

Fig. 19.—For best results on average modern recordings, the overall pick-up and tone correction characteristics should be within the shaded area when taken with the H.M.V. gliding tone record No. 4037. Some fixed notes on the back (recorded at different levels) are useful for exploring the region below 100 cycles.

ing forces on the reproducing point and thus there is a better chance of the point following the groove faithfully.

In some designs, the main treble peak is now so high up that restoration of frequencies above the resonant peak is not necessary. Also the peak (if any) can be partially dealt with by simple untuned attenuating circuits instead of accurately adjusted tuned ones. Even so, the natural curve of these latest products of the laboratory is not the inverse of the overall recording characteristic, and as their frequency scale is very wide, a corrector to provide the general slope called for by Fig. 12 is more necessary than ever.

## Valve Notes and News

A NEW Osram power tetrode has been introduced for use primarily in AC/DC sets. This is the KT35, which is priced at 10s. 6d. The anode dissipation is 10 watts, and with the maximum permissible HT voltage of 200 an output of 4.3 watts is obtainable. The filament is centre tapped and may be heated with 0.6 amp. at 13 volts, or 0.3 amp. at 26 volts.

The Osram GU5 mercury vapour rectifier has been replaced by a new type, the GU50, designed to give greater reliability at the maximum rating. The permissible RMS input is 1,500 volts, and the maximum current with delayed switching of the anode voltage, 250 mA. The price is 25s., and a permit is required for sale or purchase.

Marconiphone announce a new range of 1.4 volt valves with octal bases for "all-dry" battery operation. These include the X14 heptode frequency changer with a conversion conductance of 0.25 mA/V, the Z14 RF pentode with an AC resistance of 1.5 MΩ, the HD14 double-diode-triode with a stage gain in the triode section and a maximum output of 8 volts RMS with 5 per cent. distortion, and the N14 output pentode giving 250 milliwatts for 10 per cent. distortion with 90 volts HT.

The VMP49 will be supplied in future to replace the Marconiphone VPM4, which is no longer in production. As the latter valve had a 5-pin base, the VMP49 will in future be available with either a 5- or 7-pin base.

In future, the suffix M will be added to the type number of all Marconi and Osram valves with metallised bulbs.



is provided without any obtrusive "boom" or harshness.

Range and selectivity on all three wavebands will meet any demand that the broadcast listener is likely to make, and he will be agreeably surprised by the efficiency of the short-wave performance. There is no appreciable second-channel interference, and the range of automatic volume control is sufficient to level the fluctuations in American broadcast transmissions on most occasions. Signal-to-noise ratio is more than satisfactory, and sensitivity is uniform on each waveband.

**Constructional Features.**— The receiver is divided into two sections, the output valve being incorporated with the power pack at the bottom of the cabinet. The units are connected with each other and with the loud speaker by multiple cables with easily detachable plugs and sockets.

The tuning condenser and the receiver chassis itself are well sprung on rubber supports, and the set is

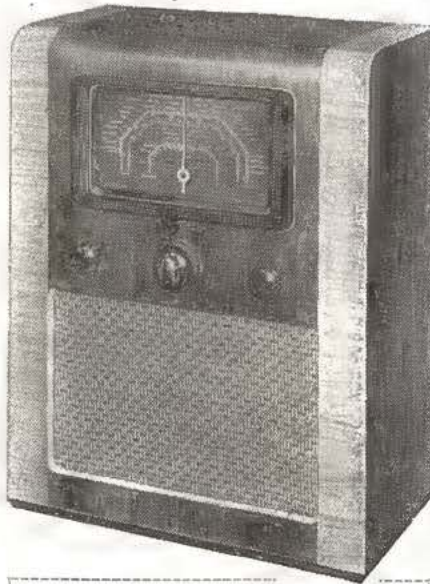

**WAVERANGES**

Short	- -	16-52	metres
Medium	- -	190-580	metres
Long	- - -	840-2150	metres

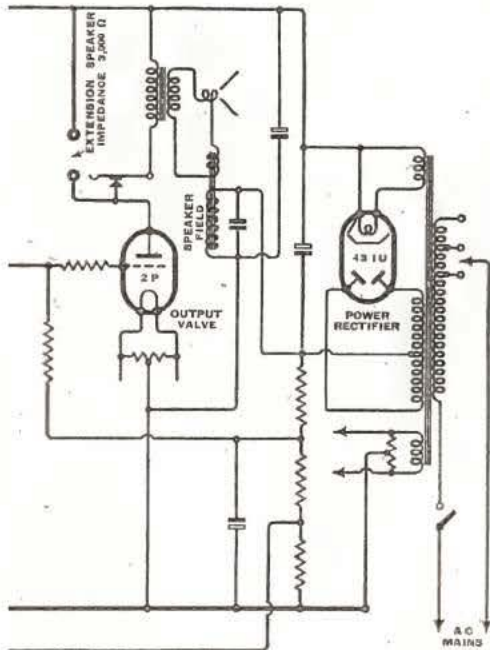

very stable from the point of view of microphony on the short waves.

The single-speed tuning control is provided with just the right compromise between the ratios normally required for short-, medium- and long-wave adjustments. The wave-range control is concentric with the main tuning knob.

The only criticism we have to

make concerns the tuning scales. The short-wave performance of this set deserves a better means of logging than the short inner scale with its crowded markings at the high-frequency end.

Makers.—A. C. Cossor, Ltd., Highbury Grove, London, N.5.

**Henry Farrad's Solution**

(See page 199)

NO, there is nothing abnormal about the result described, even though it does seem to be a hard bargain. There are two reasons why the addition of a fixed capacity to a tuned circuit takes away many more stations than it adds to the tuning range. The first is that the change in wavelength—or frequency—is proportional not to the amount of capacity added but to the ratio of the capacity change. To be more precise, it is proportional to the square root of the ratio. For example, if adding a certain amount of capacity to a tuned circuit is equivalent to increasing it in the ratio 1.25 or by 25 per cent., the wavelength is increased in the ratio  $\sqrt{1.25}$ , or about 12 per cent. Obviously then, the effect of an added fixed capacity is much greater at the low

wavelength end of the scale, where the total capacity is small, than at the high wavelength end.

How this works out in practice can best be seen by considering the example in question. As the variable condenser is a small one, a likely figure for the total capacity, with the condenser full in, including circuit capacities, etc., is 400 m-mfds. Athlone's wavelength is 531 metres, or 565 kc/s. If the maximum capacity *just* failed to take in Athlone, the frequency might well be 570 kc/s (526 metres). The addition of 25 m-mfds. is an increase of 6¼ per cent., giving a wavelength (or frequency) change of just over 3 per cent. So the new frequency is 553 kc/s (542 metres), fully covering Athlone but no other extra stations at that end. Suppose now that the original minimum capacity was 65 m-mfds., which would tune the circuit to 214 metres (1,400 kc/s). The addition of 25 m-mfds. would be an increase at this end of the scale of nearly 40 per cent., raising the maximum wavelength to 252 metres.

The wavelength change is thus considerably greater (38 metres instead of 16). But the second reason for losing many more stations than was gained is that stations are placed at approximately equal intervals of frequency—not wavelength—and the 38-metre shift at the minimum of the tuning condenser represents a much larger shift in frequency than 38

**OUR SUPPLEMENT**

WITH this issue we present an "All-wave Station Guide" printed on card for handy reference, in the hope that readers will find it a useful help when searching the ether for news and views from foreign broadcasting stations.

Long- and medium-wave channels are shown according to the Lucerne Plan, as the putting into operation of the new Montreux Plan has been postponed indefinitely. The short-wave list is comprehensive, but to avoid undue length we have omitted a few stations which, by reason of low power, unsuitable wavelength or times of transmission, are seldom heard in this country.

metres at the maximum capacity. Actually it is 210 kc/s, enough for 23 stations at 9 kc/s intervals; compared with 17 kc/s shift at the Athlone end.

Hence the "bad bargain" is not due to anything wrong, but is a result of the immutable laws of tuned circuits.

# Current Topics

RECENT EVENTS IN THE WORLD OF WIRELESS

## OPERATORS' CERTIFICATES

### The Present Position

IT does not appear to be generally known that the suspension of G.P.O. examinations for first and second class operators' certificates introduced after the outbreak of the war, is still in force. The only certificate at present issued by the P.M.G. is the Special certificate, for which the examination includes: morse, sending and receiving at 20 w.p.m.; practical working knowledge of wireless apparatus as used on board ship; and a knowledge of the regulations contained in the P.M.G.'s Handbook. The examination does not include theoretical questions.

Holders of Special certificates who have served at sea for six months or more can qualify for a second class certificate (on the resumption of examinations) on completing the examination by taking the technical or theoretical portion of it.

### B.B.C. FINANCE

CHANGES in the financing of the B.B.C. during the war are provided for in a recent agreement between the Postmaster-General, the B.B.C. and Sir John Reith, the Minister of Information, which renders the clauses of the original licence relating to finance inoperative. This clause entitled the B.B.C. to 75 per cent. of the net licence revenue, plus any additional percentage approved by the Treasury. Under the new agreement, the Minister of Information is to pay the B.B.C. from April 1st "such annual sums as the Lords Commissioners of the Treasury approve as sufficient for the adequate conduct of the services provided by the Corporation."

### B.B.C. NEWS ON SHORT WAVES

AT the request of a number of readers, we give below the times (B.S.T.) of the transmission of news in English for Europe from the B.B.C. short-wave station.

From GSA, 6.05 Mc/s (49.59 metres), and GRX, 9.69 Mc/s (30.96 metres), news is radiated at 12.30, 1.30, 7.15 and 9 a.m. and 7 and 11 p.m. From GSW, 7.23 Mc/s (41.49 metres), and GSE, 11.86 Mc/s (25.29 metres), transmissions are broadcast at 11.45 a.m., 12.30, 2.15 and 5 p.m.

## WIRELESS CONTROL

### Model Aircraft Experiments

IT should be pointed out that the Postmaster-General's recent Order regarding the remote control of machinery by wireless covers experiments with radio-controlled model aircraft, boats, etc. Such experiments cannot be carried out without a special permit from the P.M.G. Furthermore, the possession of apparatus for this purpose, although it may not be in use, is prohibited unless a permit authorising the possession is obtained from the P.M.G.

The position is somewhat complicated by the fact that, before the outbreak of war, a licence was not necessary in some circumstances for the use of low-power short-range apparatus for these experiments. Anyone in possession of such unlicensed apparatus should, therefore, regularise his position by reporting the facts to the Engineer-in-Chief, G.P.O. Radio Branch (W2/1), Harrogate, Yorks.

## BROADCASTING IN FINLAND

### Popularity of the Frame Aerial

IN order to combat Russia's systematic interference with the transmissions from the Finnish stations, which is apparently a definite part of the Russian aggression, all the leading periodicals and the lay press in Finland have published details of a standard frame aerial for home construction. When the long-wave transmitter at Lähti was damaged early in the war, Sweden lent the Motala station until the Finnish transmitter was repaired.

Immediately after the outbreak of the Russo-Finnish war, the broadcasting organisation, Soumen Yleisradio A/B, was decentralised.

It had been realised that the continuation of the broadcasting service would help enemy aircraft navigators. Energetic efforts were, therefore, made to provide a large fleet of comparatively small mobile transmitters. The regular transmissions from one or two fixed stations were picked by the mobile stations and re-radiated. In this way a unique "floating network" was provided.

In order to continue the education of Finland's 600,000 evacuees, between the ages of 7 and 16 years, a special radio curriculum was effectively brought into use.

## TELEVISION RELAYS

### R.C.A. Tests

TESTS between the N.B.C.'s television transmitter W2XBS in the Empire State Building, New York, and the R.C.A.'s laboratories at River Head, Long Island, have convinced R.C.A. engineers that a television radio relay system using a frequency of 500 Mc/s is now practicable. In the experiments, the 42.5-Mc/s transmission from New York was received 45 miles away, and converted into a frequency of about 500 Mc/s for retransmission. At this frequency the signals were received and transmitted at each succeeding relay station, which were approximately 15 miles apart. At the end of the chain of stations, the frequency was lowered to its original 42.5 Mc/s for rebroadcasting.

The transmitting and receiving apparatus at each of the 10-watt relay stations was mounted on the rooftop, mast carrying the parabolic aeri-

## STUDIO ACOUSTICS

THE two largest studios in the new seven-studio annexe to the main C.B.S. building in New York are to be fitted with revolving acoustic panels—"Acoustivanes." Manipulated by control switches, these 14ft.-high panels, which are 27in. wide, are made of soft wood on one side and hard wood on the other, in rather the same way as a violin. A cross-section of the panels, which are spaced about 3ft. from the walls, is like an aeroplane wing. There are no parallel surfaces in the studios, the ceilings of which are corrugated.

## "VESTPOCKET" O.B. UNITS

WHAT are described by the National Broadcasting Company of America as "vestpocket" units have been developed by the Radio Corporation of America for television O.B.s. The complete equipment for one camera, using a cable link to the transmitter, weighs less than 275 lb. (excluding camera and cable).

A radio transmitter working on wavelengths around one metre has also been designed. This, together with its associated power supply equipment, weighs 250 lb. A complete three-camera assembly with transmitter weighs less than 1,500 lb.



## APPARATUS BY POST

### P.M.G.'s Ruling

SINCE the introduction of the P.M.G.'s Order of November 25th prohibiting, except under the authority of a Post Office permit, the acquisition or supply of transmitters and certain apparatus which may be used in a transmitter, a purchaser has been required to quote the supplier either orally or by letter the reference number of the relative permit before obtaining the goods. To avoid the delay so far caused when the purchaser sends for the apparatus by post, it has been agreed that in future the apparatus may be despatched immediately the permit to supply (Part C of the permit form) is received by the supplier, on condition that the goods are consigned to the address on the permit.

It will, of course, still be necessary to quote the permit number when purchasing goods over the counter.

## SHORT-WAVE LISTENING

THE tremendous growth in short-wave listening is exemplified by the following details given in the National Broadcasting Company's survey of operations in 1939. In August last year 3,927 letters were received from oversea listeners, whereas in May, 1938, when the present fixed-language programmes from WRCA and WNBI (then W<sub>3</sub>XAL and W<sub>3</sub>XL) were inaugurated, the N.B.C.'s International Division received only 157 communications.

## AWARDS TO TELEGRAPHISTS

AMONG those decorated for their part in the battle with the *Graf Spee* off Montevideo was William L. Brewer, the Chief Petty Officer Telegraphist of H.M.S. *Achilles*. He was awarded the Distinguished Service Medal in recognition of his "training and organisation of the W/T Department which successfully withstood the supreme test of battle. His coolness and ability, when under fire, in repairing the damage to the radio equipment on the upper deck and below decks resulted in the *Achilles'* W/T being in full working order again in a very short time, and in getting the first enemy report through."

Telegraphists in all three ships which took part in the battle were among those mentioned in dispatches.

Telegraphist V. H. Penfold, of the Royal Naval Volunteer (Wireless) Reserve, was among those who were recently decorated for successfully carrying out dangerous experimental work on enemy mines. He was awarded the Distinguished Service Medal.

## ROME WORLD FAIR

PREPARATIONS for the 1942 World Fair which is to be held in Rome are proceeding apace in spite of the international situation.

The Radio Palace, which is to be a feature of the Fair, will house historical shows of wireless telegraphy and telephony and television, an exhibit depicting the most recent developments of the Italian wireless and television industries and several studios from which actual sound and vision programmes will be transmitted.

## ALTERNATIVE PROGRAMMES

THE recently introduced 12-hour B.B.C. transmission for the Forces is providing a welcome alternative to the Home Service over a large part of the country. Mr. Bishop, B.B.C. chief engineer, recently stated that the transmissions should give a second-class service over the whole country. From March 17th to September 21st, the time of the change from the daytime wavelength of 373.1 metres (804 kc/s) to the evening wavelength of 342.1 metres (877 kc/s) has been fixed at 10 p.m.

Some notes on the reception of the B.B.C.'s Home Service are among the many interesting features contained in the B.B.C. Handbook, 1940, which has just been published at 2s.

## FROM ALL QUARTERS

### Obituary

WE regret to record the passing, at the age of 68, of Lord Crawford and Balcarres, who, it will be remembered, was chairman of the Committee which in 1925 recommended the transformation of the British Broadcasting Company into a public Corporation.

### It Has Been Said

"If the paper shortage is to restrict printed advertising, then radio will have to take its place, for advertising *must* go on," says the reviewer of a new book, "Radio as an Advertising Medium," in a recent issue of *Advertisers' Weekly*.

"The radio, by propagating mental



RADIO ROYAL, the listening station of Allied Newspapers, Ltd. A corner of one of the reception rooms where linguists and wireless technicians receive the news transmitted from the world's broadcasting and telegraphy stations. The news is passed to the editors for inclusion in the following morning's daily papers in the Allied Newspaper group. The receivers, which include communication receivers and a ship's set, have a coverage of from 5 to 22,000 metres. Each receiver's output can readily be connected to a recorder. The station was designed and is under the direction of Mr. Charles D. Kidd.

# Wireless World

## Current Topics—

poison, is more profoundly sinister and more refinedly barbarous than the aeroplane which merely broadcasts high explosives. Turn the knob and there will come over the air voices speaking with the tongues of men and of angels; but delivering the composition of prevaricators and propagandists."—*Aeronautics*, February, 1940.

"This is the first radio war. Wireless not merely reflects the course of events; it has become something which helps to shape their course. It was in a broadcast from Danzig that Hitler made his so-called peace offer to the Allies; it was on the air that Molotov rejected Finland's proposals; and that Finland made its appeal to the United States. . . . Broadcasting is a mechanical art; and, like all the mechanical arts, it has no virtue but in the use men make of it. It can be perverted to the uses of tyranny, or it may be able to help immeasurably in advancing the cause of liberty and civilisation."—Mr. F. W. Ogilvie, B.B.C. Director General.

## Listeners in Germany

THE number of licensed listeners in Germany at the beginning of last December was 13,435,301. This number includes the listeners in Austria, but not those in Memel, the protectorates Bohemia and Moravia and German-occupied Poland. The above figure shows an increase of roughly three-quarters of a million in the first three months of the war. Bohemia and Moravia have approximately 750,000 licensed listeners.

## Old Records for New

IF one wishes to purchase a new gramophone record in Germany to-day it is compulsory to hand in an old record. Since the outbreak of the war, Germany has been unable to import any shellac (the main constituent of solid-stock discs) from India or Burma, which countries have a virtual monopoly in the production of this commodity. So the old records are re-processed, and it is estimated that this measure will yield 3,000,000 used records.

## Servicing in Denmark

UNDER a new law in Denmark, radio servicemen will have to pass an examination, after serving a specified term of apprenticeship, before being granted a licence to start a business.

## Scandinavian Radio Telephony

THE plan to lay a new marine cable across the Cattegat between North Jutland and West Sweden for telephonic communication has been abandoned. Instead, the authorities are to establish a two-way short-wave beam telephony service.

## "The Stuff to Give the Troops"

OVER 2,000 troops of the Northern Command were recently entertained in the Newcastle City Hall to a concert which consisted largely of recorded music. The apparatus used included a *Wireless World* 30-watt amplifier and four Voigt speakers. Mr. Wm. Pope (of *The Newcastle Evening Chronicle*), a former Hon. Secretary of the Newcastle Radio Society, who arranged the entertainment, was assisted by Mr. P. G. A. H. Voigt, who took the opportunity of trying out under practical working conditions a new pick-up on which he is experimenting.

## U-H-F "Duplex" Working

AMERICAN amateurs are now permitted to operate "duplex" on frequencies above 112 Mc/s. Until now telephony stations have been forbidden by the Federal Communications Commission to emit a carrier wave unless modulated for the purpose of communication.

## I.E.E. Meetings

AT the request of members of the I.E.E. two papers published during the period when there were no meetings will be read at the Wireless Section meeting, on Wednesday, April 3rd, at 6 p.m. The papers are "Reflection Curves and Propagation Characteristics of Radio Waves Along the Earth's Surface," by Dr. J. S. McPetrie and Miss A. C. Stickland, and "An Experimental Investigation of the Propagation of Radiation having Wavelengths of Two and Three Metres," by Dr. McPetrie and Mr. J. A. Saxton. At an informal meeting at 6 p.m. on April 1st, Mr. P. G. A. H. Voigt will open the discussion on "Electro-Acoustics in Practice."

## Institution of Electronics

A MEETING of the Institution of Electronics will be held on April 4th, at 6 p.m., at the Royal Society of Arts, John Street, Adelphi, London, W.C.2, when Professor D. R. Hartree, M.A., F.R.S. (University of Manchester), will give a lecture on "Wave Mechanics." Tickets of admission are available from the secretary, Mr. Alexander H. Hayes, 27, Fetter Lane, London, E.C.4.

## Our Cover

THE symbolic illustration on our front cover is reproduced by courtesy of the Postmaster-General.

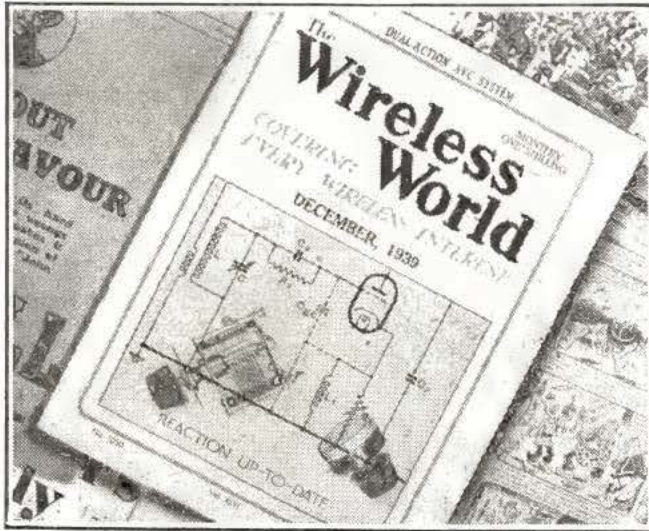

AN OBLIQUE REMINDER to order your *Wireless World* is contained in the film "Raw Material is War Material," from which this "shot" is reproduced. This journal is featured among the specialist publications which require regular supplies of paper. Sponsored by the Thames Board Mills and produced by Crichton Film and Radio Publicity, the film stresses the need for conserving supplies of paper and for turning all waste to good account.

## Our Birthday

WITH the publication of this issue *The Wireless World* enters upon its 30th year of publication. It was in April, 1911, as *The Marconigraph*, that the first issue was published.

## U.S.A. Standard Frequency

WITH the exception of short periods on three days of the week, WWV, the station of the American National Bureau of Standards, is now giving a continuous twenty-four-hour transmission of a 440-cycle note on a frequency of 5,000 kc/s with a power of 1 kW.

## "Wireless for the Blind" Fund

THE annual report of the British "Wireless for the Blind" Fund reveals that during the ten years, since its inception in 1929 to the end of last October, nearly £166,000 has been collected. Of this sum, £151,500 was expended on sets and accessories for blind listeners.

## Radio Officers

IN common with navigating and engineering officers, radio officers in the Merchant Navy received an increase of £2 per month from March 1st.

## Gear Wanted

THE Officer-in-Command of the St. Clement Danes' Sea Cadet Corps is appealing for wireless apparatus in order to equip the signal school. Readers who have headphones, morse keys, HT and LT eliminators, trickle chargers, switches, terminals, wire, etc., among their "junk" are asked to send it to the Officer-in-Command, St. Clement Danes' Sea Cadet Corps, The Schools, Drury Lane, London, W.C.2.

## Japanese Television

ON February 11th, the Japanese Empire Day, when the 2,600th anniversary of its foundation was celebrated, a regular twice-weekly television service was inaugurated.

# Letters to the Editor

THE EDITOR DOES NOT NECESSARILY ENDORSE THE OPINIONS OF HIS CORRESPONDENTS

## "Aids to Hearing"

I SHOULD like to express my appreciation of the article in your March issue by Dr. Littler; particularly of its comprehensive character and the details of the testing apparatus.

It is submitted, however, that in discussing the cost of alternative LT supplies less than justice is done to accumulators by not dealing with the case where they are charged at home. A 2-volt trickle charger costs a little over 10s. and usually gives about  $\frac{1}{2}$  amp. This is too high for most midget cells, but a rheostat in series and a .5s. ammeter overcome that difficulty.

Nothing is more difficult to estimate than the amount of daily use of a hearing aid, but I suggest that it is generally underestimated, and that four hours per day is a very conservative estimate. A social evening alone may last that length of time. According to my experience—admittedly limited—of dry-battery LT supply, voltage shows such a material drop after even three hours that great loss of volume and distressing amplitude distortion is caused.

In the past four years my 2-valve carbon microphone aid has used up two  $3\frac{1}{2}$  Ah. jelly acid accumulators and a third is beginning to show signs of age. These batteries cost 8s. 3d., which works out at nearly 20 hours for one penny running cost. Allowing 80 per cent. efficiency, the cost of charging is only one penny per annum with electricity at  $\frac{1}{2}$ d. per unit.

I think that deaf aid manufacturers would help themselves by supplying their customers with trickle chargers and teaching them how to use them.

Glasgow.

JOHN A. HAMILTON.

## Home-built Morse Recorder

MAY I suggest a modification to the morse recorder described in last month's *Wireless World*? It seems to me that the home-made inking pen might with advantage be replaced by a ready-made stencil pen of the type used by draughtsmen for lettering. The particular type I have in mind is the "Uno," which has an ink reservoir of ample capacity; the smallest size (No. 0) should make a line of the required fineness.

"Uno" stencil pens are sold by dealers in drawing office materials, and are quite cheap.  
London, S.W.20. H. J. COOKE.



## Morse Key Manipulation

THERE seems to be some difference of opinion as to the correct method of holding and manipulating a morse key; in view of the present importance of morse operating to many of your readers, I hope that you will be able to devote a little space to clearing up the matter.

I gather from passing references to the subject in your pages that the key should be mounted near the edge of

the table or operating bench, the knob being held lightly between the first two fingers (which rest on the top) and the thumb (which rests on the lower part of the side). The contacts are closed by dropping the wrist, the forearm being in line with the bar of the key, but at a rather higher level.

On the other hand, photographs of American stations

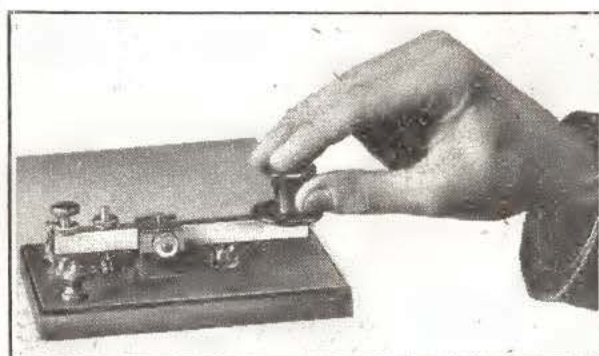

Is this the right way to hold a key?

would suggest that the key may be mounted a foot or more from the edge of the bench, with the obvious intention of providing a rest for the forearm, thus involving a rather different signalling technique. Which is best, or is it merely a matter of taste?

"RADIOPHARE."

## Probe Valve Voltmeter

IT is regretted that the values of components for the modified valve voltmeter discussed by Mr. J. Harris in "Letters to the Editor" last month were omitted. The values are as follows. Resistances: R1, 6 megohms; R2, 3.5 megohms; R3, 0.42 megohm; R4, 0.21 megohm; R5, 49,000 ohms; R6, 14,700 ohms; R7, 750 ohms; R8, 10,000 ohms; R9, 10,000 ohms, 6-watt; R10, 50 ohms variable; R11, 25 ohms. Condensers: C1, 0.1 mfd.; C2, 20 m-mfds.; C3, C4, C5 and C6, 2 mfd's. Transformer secondary: 135V, 60 mA. Rectifier: Westinghouse HT8.—[ED.]

## Wireless in the Air

WORK OF THE R.A.F. RADIO MECHANIC

THE skill and training that service men have acquired in order to give efficient maintenance service to ordinary broadcast receivers is standing them in good stead now, as many of them have obtained congenial billets with the R.A.F., where their skill can be put to good use. Wireless equipment installed aboard military aircraft needs considerably more attention than that used by the ordinary listener, for the simple reason that the conditions under which it is operated are far more rigorous.

In the first place, aircraft apparatus has to withstand a large amount of vibration and jolting. In order to offset this, radio gear is usually mounted in a cradle and slung from shock-absorbers, which can be removed bodily from the aircraft in order to facilitate repair work.

Wireless in the Air—

Atmospheric changes account for another of the trials to which aircraft radio gear is subjected, and although much is done to counteract this in the design and construction of the apparatus, a good deal of attention is needed on the part of the service engineer on this account alone.

Another feature of aircraft wireless which claims a good deal of the radio mechanic's time is the maintenance of the metal bonding of the machine. Each separate metallic portion of the aircraft has to be carefully bonded to the others by copper wire. If this were not done, the separate metal parts would tend to collect dangerously high static charges when flying through clouds, and a flash-over would result. Another reason for the bonding is to improve the efficiency of the screening which is adopted to cut out

electrical interference from ignition system of the engines.

Each hangar has its wireless work bench, where the radio mechanic carries on his work. Not only has the actual aircraft wireless gear to be kept in first-class order, but also the apparatus used at the ground stations. Transmitters are commonly operated by remote control from the receiving desk, and this involves the use of relays and of land lines, the proper maintenance of which is yet another of the responsibilities of the radio mechanic.

Although a very great number of wireless service men and others have joined this branch of the Service, more are still required. Since the conditions of service are good and the opportunity of acquiring specialised knowledge, of great use on return to civil life, is great, it is not expected that there will be much difficulty in filling the vacancies.

## Denco "Pocket-two"

### AN ECONOMICAL MINIATURE BATTERY RECEIVER

DESIGNED as a "personal" set for those on active service, and as a standby receiver for the home, the "Pocket-two" is built into a tinned iron box measuring 4½ in. x 3 in. x 1½ in. The effective overall dimensions are, however, 5½ in. x 3 in. x 2½ in., and, although this is still quite small, the set would no doubt be easier to stow away

in a pack if shallower knobs were fitted for the tuning and reaction controls. This is a matter which is easily remedied and would put the finishing touch to an extremely efficient little receiver.

Two Hivac mid-ge valves are employed as reacting detector and output stage in the Denco "Pocket-two."

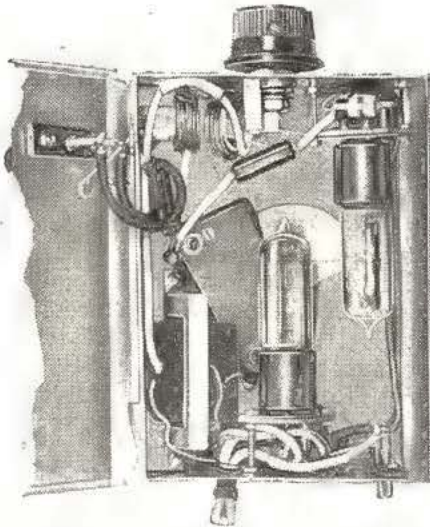

The waverange covered is 200 to 500 metres, and with roft. of wire as an aerial excellent reception was obtained from two or three of the more powerful Continental stations as well as those of the Home Service. With a slightly longer aerial the output was sufficient to work a small loud speaker on the latter stations. When using the set on a full-sized outdoor aerial a small series condenser is advisable in the interests of selectivity, but this is not necessary with aerials up to about 20ft. in length.

Reaction is smooth but by no means critical, as the set retains its sensitivity for a long way below the oscillation point. A full 60 volts HT is recommended; if the voltage falls below 45 volts reaction to the oscillation point is obtainable only in the lower half of the dial. In the model tested, the HT consumption was 1½ mA at 60 volts. The LT current was just under 0.12 amp. Crocodile clips are provided for the LT battery, and a removable resistance is included in the positive lead so that the set may be run

either from a 3-volt dry battery or a 2-volt accumulator.

The two-valve circuit comprises a leaky grid detector, with reaction on the well-tryed, if recently neglected, swinging coil system. This is transformer-coupled to the triode output valve; the headphones are connected directly in its anode circuit. The workmanship is neat and the wiring sound, and the set generally gives the impression that it will give long and reliable service.

The makers are Denco, Warwick Road, Clacton, Essex, and the price, exclusive of batteries and 'phones, is £2 15s.

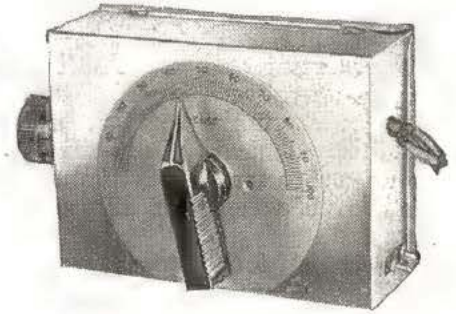

## Reducing Ignition Interference

Although attention to the reduction of radiated interference from ignition systems by means of screening has been largely confined to aero engines, the humbler machines have not been entirely neglected, and a



number of screened magnetos and distributors for engines with from one to eight cylinders have recently been introduced by the B.T.H. Company. The photograph shows a single-cylinder screened magneto.

# The Differential Calculus

By "CATHODE RAY"

(Everybody Knows It)

MORE MATHEMATICS WITHOUT TEARS

SOME while ago\* I tried to bring the anti-mathematicians round to a right way of thinking on the subject, showing that the dreaded letters and symbols really do make things easier and not more obscure. It was necessary to point out that they are used for several distinct purposes, as failure to realise this may account for a good deal of the feeling that only certain highbrow persons are capable of understanding them. The purposes mentioned were:

(1) As labels for items in a diagram, such as  $R_1$ ,  $R_2$ , etc., to distinguish certain resistors. This, of course, is not a mathematical use at all, and is mentioned only because the same letters, perhaps even referring to the same resistors, are sometimes used in mathematical formulæ—a practice that may possibly cause confusion if the distinction is not understood.

(2) As abbreviations; for example  $H$  for henrys,  $mA$  for milliamps, and  $\Omega$  for ohms. This also is no more mathematical than such familiar abbreviations as N.W., £, \$, or A.R.P.

(3) As a sort of stand-in, to represent a number that is either unknown at the moment or can more conveniently be written as a letter. An example of the latter is  $\pi$  to represent 3.1415926535 . . . and so on.

(4) As an instruction to do something. Everybody knows that  $+$  is an instruction to add the number that follows, and most people know that  $\sqrt{\quad}$  means "take the square root of" whatever is written under it; but the significance of  $\int$  and  $\frac{d}{dx}$  is less widely understood. In fact, where it is known that these particular symbols have to do with the Calculus (or, in full, the Differential and Integral Calculus) there is a

powerful urge to heave the book containing them away, and turn to lighter literature.

## An Old Story

I am not going to be so foolhardy as to attempt here and now a treatise on this particular branch of mathematics, but it may be news to some to know that the basic principles of this awe-inspiring subject are really quite familiar to everybody. Or, at least, to everybody who is able to see the point of the chestnut-flavoured story about the motorist who was accused of doing 50 miles an hour on a restricted road, and indignantly retorted that he couldn't have been, because he hadn't been out an hour yet. When you grin indulgently at that you do so because you know that a motorist doesn't need to travel 50 miles in order to be travelling at 50 miles an hour. 50 m.p.h. is a speed.

And what, may I ask, is a speed? Some dictionaries, even, are a bit shaky when faced with this question. They are apt to shift the responsibility on to some other page by referring you to "rapidity," "velocity," "swiftness," and so on; and when you look them up they are defined as "speed." Having thrown the dictionary where it deserves, and fallen back on one's own mental resources, one can profitably consider the units in which speed is specified. "Miles per hour." As we look with pity on the man in the story who couldn't see the difference between this and "miles in an hour," we presumably know what "per" means. I suppose the answer would be that 50 miles per hour means a speed which, if maintained for one hour, would traverse 50 miles.

But as nobody ever does maintain exactly such a speed for a whole hour, the question arises—how is

speed actually measured in practice? The police are interested in this problem, because they are required to give legal evidence on the matter. One way in which they attempt to do so is by measuring the time taken by the suspected motorist to cover a measured distance, say, a quarter of a mile. The argument is that one mile in  $1/50$ th of an hour, or quarter of a mile in  $1/200$ th of an hour (18 seconds) is the same speed as 50 miles an hour. Note that this argument still hangs on the assumption that the speed is maintained constant throughout the distance concerned. It seems reasonable to suppose, however, that a measurement made over quarter of a mile is likely to give a better clue to the motorist's real speed than one made over 50 miles. Actually, of course, he may have covered part of that quarter-mile slower than 50 m.p.h. and part of it faster. Still, it gives the police all they want to know, viz., that he must have been travelling at a speed of at least 50 m.p.h.

## The Time Interval

We, having a more scientific outlook on life than the police (bless them!) have still not got the problem altogether taped to our satisfaction. Continuing to pursue the principle that a better approximation is obtained by shortening the distance over which the average speed is measured, we might try one yard. The time to be measured is now only a fraction of a second, so a police stop-watch is no good; but the radio man is not likely to find much difficulty in applying his photo-cells and cathode-ray oscillographs to such a problem. Only an impossibly pedantic person is likely to object that, as the speed of the car may have varied while covering the measured yard, we have still not got the exact speed in miles per hour. Yet, of

\* April 21st, 1938.

## The Differential Calculus—

course, he is quite right. Although the accuracy is good enough for almost anybody where cars are concerned, it is definitely not so in the proverbial problem of timing flies. They might easily slow to a standstill, and even get into reverse, well within a yard. If you protest that no serious radio man would engage in such a frivolous pursuit, especially in wartime, what about the speed of the spot of light on an oscillograph screen? Or, for the matter of that, the muzzle velocity of a bullet.

Evidently it is necessary to go still farther in reducing the distance over which the speeding object is timed. It is clear that however small it is made the same objection can be raised, at least in principle. Meanwhile, the difficulty of measuring increases. It seems that the only way of satisfying the demand for perfect accuracy, when the speed is varying all the time, is to make the measurement at the exact point at which a knowledge of the speed is required. A point, as we know, has no magnitude; so, however refined our apparatus, the measurement has become impossible! Too bad, just when it would be theoretically exact!

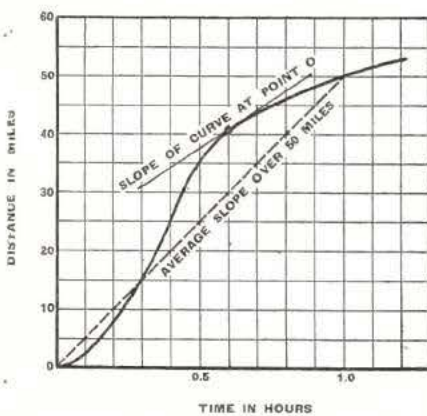

Fig. 1.—Graph of a journey showing how the speed at any point *en route* is the slope of the curve. This is an example of a type of problem that is very common in radio.

The foregoing is painfully elementary, no doubt; but that very fact shows how anybody, without vast mathematical knowledge, can cover the ground occupied by the first chapter in the Differential

Calculus. At the same time, some hint of difficulties ahead is given by our conclusion that measurement of a varying speed is theoretically exact only when made under impossible conditions. Put another way, if  $t$  is the time in hours required to travel a space of  $s$  miles,  $\frac{s}{t}$  is the average speed in miles per hour. By making  $s$  and  $t$  very small, a closer approximation to the actual speed at any given position can be obtained. It is only when  $s$  and  $t$  dwindle to nothing that theoretical exactitude is reached. But  $\frac{0}{0}$  is

meaningless. Look at it from yet another angle. Suppose the time at which various distances are reached on a journey are plotted as a graph, such as Fig. 1. This graph shows that 50 miles have been covered in one hour, so the average speed is 50 m.p.h. over that distance. If it had been maintained throughout, then 25 miles would have been covered in half an hour (it actually took only 0.4 hour), and so on, giving a straight sloping line as shown dotted. A lower steady speed would be represented by a straight line with a less steep slope. Speed, in fact, is represented by steepness of slope.

To find the speed at a position 40 miles from the start it is necessary to find the slope at that point. That is done by taking two other points very close together each side of that point, joining them by a straight line, and measuring the slope of that line. Over such a short distance the straight line is hardly distinguishable from the curved line representing the actual speed of the car. But perfect exactitude is achieved only when the two points are made to coincide—and then how can you draw a straight line joining them?

## Rate of Change

Most of us are not greatly concerned with measuring the speeds of cars with extreme accuracy. Voltages in a circuit are more in our line. Very well, then; the voltage across a coil is equal to its inductance in henrys multiplied by the rate at which the current through it is changing. This is the same type of problem as the one we have

been considering—the rate at which distance is changing. Just substitute amps for miles, and there you are.

“Rate” generally means the increase (or decrease) of something with regard to time. We are thinking of that when telling somebody not

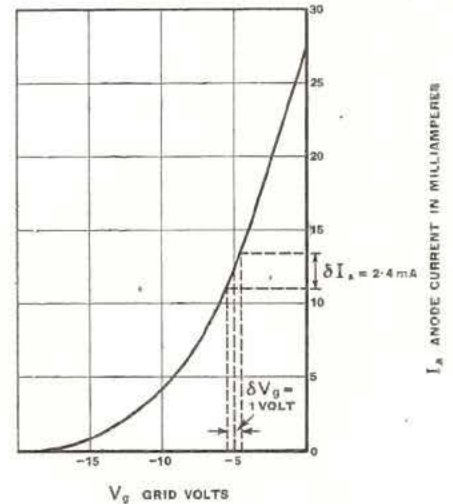

Fig. 2.—The slope (mutual conductance) of a valve curve depends on the point selected. An approximate result is given by measuring (by meter or from the graph) the change in current due to a change in voltage near that point. It would be 2.4 mA/V in this example.

to talk at such a rate. But it isn't necessarily so. There is the mutual conductance of a valve, commonly known as “slope.” To show this on the graph it is necessary not only to substitute millamps for miles, but also volts for hours (Fig. 2). Mutual conductance is the rate of change of anode current with regard to grid voltage. In spite of what is often implied, valve curves are never absolutely straight; so the same problem arises, of measuring the slope at a point. If done by measuring the increase in millamps when the grid bias is reduced by 1 volt, the result is only an average over a section of the curve.

To get reasonably good approximations in all these cases—and many others of the same type—it is necessary to take the ratio of two small quantities, distance and time, current and voltage, etc. To show that they are small, it is customary to prefix them by the Greek letter  $\delta$  (delta), standing for “difference,” a small difference in a larger quantity. So if we represent velocity

## The Differential Calculus—

(a rather special kind of speed) by  $v$ , then  $v \approx \frac{\delta s}{\delta t}$ . The wavy "equal" sign shows that it is a little white lie—equal enough for practical purposes, but not perfectly equal. We have already seen that perfect theoretical accuracy is obtained only when  $\delta s$  and  $\delta t$  are vanishingly small—infinately small, if you like. Without troubling about the grave practical measuring difficulties involved, let us distinguish these relentlessly reduced quantities by using honest British (really Roman, I believe) letters. We are then entitled to use a genuine "equals," thus:  $v = \frac{ds}{dt}$ .

This is nothing less than undiluted Differential Calculus. To pursue the thing still further, it may not by now be too big a step to suggest that  $\frac{d}{dt}$  has a significance all on its own. How is speed related to distance? Putting it in correct language, it is the rate of change of distance with regard to time. Looking at it from the graphical standpoint, it is the *slope*, when distance is measured along the vertical scale and time along the horizontal.  $\frac{d}{dt}$  therefore can be read as "rate of change with regard to time" of whatever it is put before— $s$ , in the above example.

### Other Notations

As rates can be with regard to grid voltages, values of houses, or in fact anything,  $\frac{d}{dx}$  is a more general way of putting it. Some writers economise by putting  $D$  instead of  $\frac{d}{dx}$ , but are at a disadvantage when it comes to specifying  $x$  more particularly. The great Sir Isaac Newton, who was one of the two originators of the differential calculus, concentrated on slopes with respect to time, and used a very quick notation—just a dot, thus:  $v = \dot{s}$ .

The main thing, however, is to make sure that  $\frac{d}{dx}$ , or anything that means the same thing, is not mistaken for the ordinary algebraical

" $d$  divided by  $dx$ " which, of course, would be simplified to  $\frac{1}{x}$ .

I have still dodged the awkward question of how the slope between two points is to be measured when those points coincide. Well, one way of doing it is to look for some sort of effect that depends not on distance ( $s$ ) but on its differential with regard to time ( $\frac{ds}{dt}$ ,  $Ds$ , or  $\dot{s}$ )—

we can use the proper language now. For example, the voltage generated by a dynamo is proportional to the speed of rotation, and that principle has actually been used in speedometers. It is about the only sort of way of tackling it when the quantity in question is varying irregularly, like the speed of a car or the voltage across a modulation choke. When the quantity varies according to a known "law," then its slope can be calculated. That is the job of the differential calculus. As I said, I am not letting you in for a full-dress treatise on it; but it may be interesting to know what it is all about. Here is a simple example: if  $s = K$  (any constant quantity), that is to say if the distance is fixed, then the car must be standing still, and the velocity is nil. The first formula in the calculus, then, is

$$\text{if } s = K, \frac{ds}{dt} = 0.$$

The next simplest case is a car going in such a way that the distance is always proportional to the time. We can put it as  $s = Kt$ . The speed is, of course, constant, so the second formula is  $\frac{ds}{dt} = K$ .

And so on. If the way in which one quantity varies in terms of another is known, then the differential calculus gives a formula for calculating the rate of variation, or slope.

Sometimes the process can be repeated. Acceleration, for instance, is the rate at which *velocity* is varying. If we represent it by  $a$ , then  $a = \frac{dv}{dt}$ , and as  $v = \frac{ds}{dt}$ ,  $a = \frac{d^2s}{dt^2}$ , or

$D^2s$ , or  $\ddot{s}$ . By *differentiating* twice in the example just given, in which  $s = Kt$ , it is a very simple little exercise to show that the acceleration is nil.

The value of the differential calculus is not only that it enables one to work out all sorts of things that would otherwise be difficult or impossible, but it gives one a clearer idea of the relationship between things like distance, velocity and acceleration, or voltage and current in AC circuits.

The Integral Calculus is just the reverse problem—given the slope, to find what it is the slope of. Or to add up an infinitely large number of infinitely small things, such as journeys at slightly different speeds to give the total distance covered. It is generally more difficult. The warning sign is  $\int$ .

## H.M.V. "All-dry" Portable

THE new Model 1403 with which the Gramophone Co., Ltd., have entered the "all-dry" portable market is a 4-valve superheterodyne, housed in a neat, leather cloth covered case measuring 10 $\frac{1}{2}$ in. by 14 $\frac{1}{2}$ in. by 7 $\frac{1}{2}$ in. The weight, complete with batteries, is 21 lb. 13 oz. and the price £8 10s. 6d.

The frame aerial is wound on the back panel of the set in helix form and covers the medium-wave band from



A special lightweight loud speaker and a full size station-calibrated dial are features of the H.M.V. Model 1403 "all-dry" battery portable.

200 to 565 metres. For long-wave reception the range is extended by an iron-cored loading coil and the wavelengths covered are 850-2,000 metres.

A combined 99 volt HT and 1 $\frac{1}{2}$  volt LT battery supplies the valves, and has a life of approximately 250 working hours. A plug and socket change-over device enables separate HT and 1 $\frac{1}{2}$ -volt bell-type LT batteries to be used if desired.

# Ultra-short-wave Aerial Systems

## THEIR CHARACTERISTICS AND DESIGNS

**T**HE simplest form of aerial for the reception of ultra-short-wave signals comprises a half-wave dipole, which is a self-resonant system. An aerial of this type in which the upper and lower elements consist of electrical conductors each having a length equal to about one-quarter of the wavelength to be received is commonly used. The equivalent circuit of this dipole is nothing more or less than a simple tuned circuit possessing L, C and R values, of which L and C are determined by the linear dimensions of its elements and R by its effective coupling with the ether, which endows it with a value of the order of 80 ohms. An ordinary tuned circuit would normally possess a much lower resistance, probably a few ohms, so that since the selectivity of a tuned circuit is inversely proportionate to its RF resistance we would expect the tuned dipole to exhibit a much broader resonance curve than a carefully designed tuned circuit.

The curve shown in Fig. 1 was measured on a simple dipole comprising two lengths of brass tubing of approximately  $\frac{3}{8}$  in. diameter. It can be clearly seen that this curve is substantially flat for at least 5 Mc/s on either side of resonance. This is fortunate so far as television reception is concerned, because if the dipole were sharply resonant it would be impossible to receive simultaneously both vision and sound transmissions at high efficiency, since these are (or rather, were) spaced 3.5 Mc/s apart. Furthermore, a high order of selectivity would attenuate seriously the higher frequencies in the side bands associated with the vision transmission, since it is necessary for them to occupy a total band width of at least 3.0 Mc/s to give good reproduction of the picture.

This natural broadening of the

By F. R. W. STRAFFORD  
(Research Dept., Belling and Lee, Ltd.)

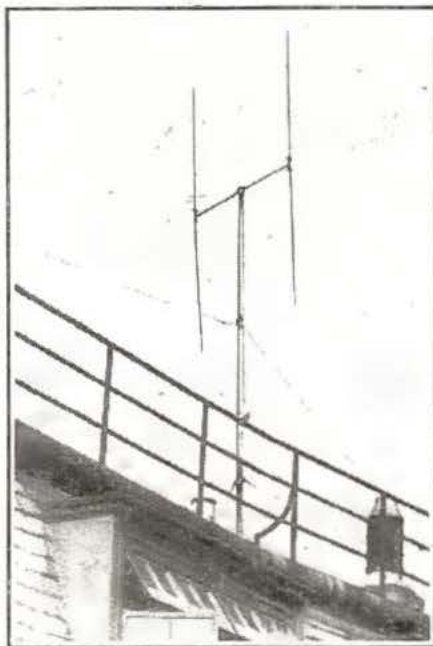

Although most people have a general idea of the principles underlying the dipole aerial as used for USW work, comparatively few possess any worthwhile knowledge of its characteristics, or of the practical points involved in its design. The author, who has had considerable practical experience in this connection, here deals with the subject comprehensively

selectivity curve of the dipole is, as stated, brought about by the high ohmic resistance introduced by the radiation of the aerial. This radiation resistance must not be confused with the ohmic resistance of the conductors comprising the upper and lower elements, for this is only of the order of a fraction of an ohm even at ultra-high frequencies. The radiation resistance is introduced in a complicated manner purely by virtue of the contrary field radiated by the dipole when the transmitted field acts upon it and produces a current in it. The whole process is abstract when one tries to visualise the effect, and is better understood by reference to the problem in its general mathematical form, but this

is far beyond the scope of the article, and no attempt will be made to tackle the problem from this angle.

The theoretical value of the radiation resistance of a half-wave aerial is 72.3 ohms, although there still appears to be some doubt as to whether this constitutes an upper or lower limit to the oscillatory curve of radiation resistance plotted against height above the earth. In any case, it assumes that the aerial is placed at an infinite distance from the earth, and as this is obviously not a normal condition of operation we must consider whether the figure of 72.3 ohms is strictly applicable under practicable circumstances.

### Mechanical Factors

Now radiation resistance is by no means simple to measure, particularly at ultra-high frequencies, but by a series of tests carried out at various times by the author the value would appear to be of the order of 80 ohms—perhaps a little higher. Since the radiation resistance vastly predominates in magnitude over the ohmic resistance

of the dipole elements it is quite clear that it is not particularly important what type of metal is employed in their construction. Copper, brass, steel and aluminium are all quite suitable for the purpose, and the size may vary between 14 SWG and  $\frac{1}{8}$  in. diameter, providing small end corrections are made to allow for the slight variation in their LC product which, of course, determines their resonant frequency. The choice of suitable materials for the dipole element depends very largely upon the mechanics of the system and its capability of withstanding high wind pressures, and also, of course, upon obvious economic factors. For steel rods of  $\frac{3}{8}$  in. diameter it would appear that the calculated length



## Ultra-short-wave Aerial Systems—

should be multiplied by a factor of 0.9 in order to effect the necessary correction to bring about resonance at that wavelength for which the calculation was initially made. For example, the calculated length for a half-wave aerial for maximum response at 45 Mc/s is 10ft. 11.25in., but maximum response in practice occurs when the length is reduced to approximately 9ft. 10in., which is the figure given by multiplying by the correction factor. A dipole designed with each element 4ft. 11in. long makes a total of 9ft. 10in. and will provide maximum response at or very near to a frequency of 45 Mc/s.

## Polarisation Planes

The response of a dipole depends upon its orientation with respect to the plane of polarisation of the transmitted wave. Television transmissions, for example, are vertically polarised, and this requires that the dipole be likewise disposed to provide a maximum response. The curve of amplitude of response plotted against departure from the vertical is a simple cosine curve, so that it follows that departure from the perpendicular up to at least 10 degrees in all directions is permis-

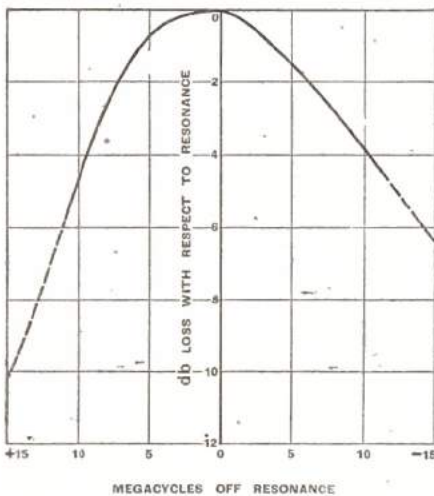

Fig. 1.—Frequency response of a simple dipole working into 80 ohms and resonating at about 45 Mc/s.

sible with negligible variation when receiving vertically polarised waves. It is only when the dipole is passing through the last 45 degrees towards

the horizontal position that the response falls off rapidly. This statement, however, should not be

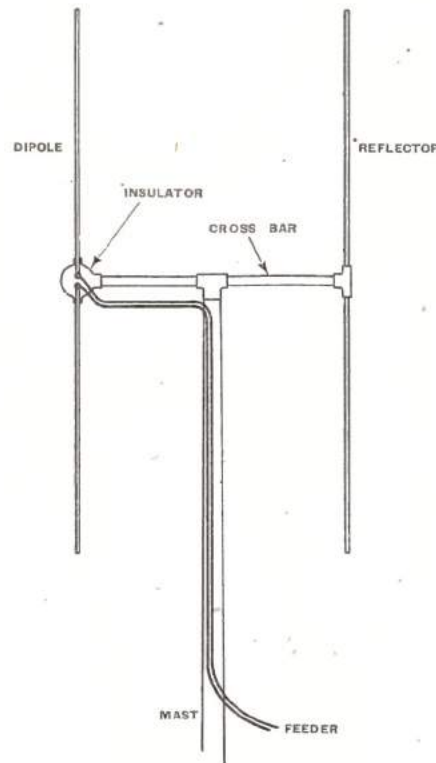

Fig. 2.—A dipole and reflector of the type generally employed for television reception.

regarded as an excuse for the careless installation of such aerials, for nothing looks worse, particularly when the aerial is fitted with a reflector.

It is hardly necessary to state that a simple dipole erected vertically is not directional in the azimuthal plane, so that it can have no discriminating effects against signals or interference arising from directions which differ from that of the desired transmission. It is in this latter respect that the addition of a reflector to the aerial, apart from increasing the signal strength about 1.8 times (theoretically twice), provides the means for obtaining useful rejection of signals and/or interference emanating from directions which do not coincide with the direction of the desired transmission. The design of the reflector as regards its length and the spacing between it and the dipole is exceedingly important, for it is becoming realised as our experience increases that discrimination against interference is in most cases

far more important than increasing the signal strength.

In Fig. 2 is depicted a dipole with its associated reflector, the whole system representing what is very commonly employed for USW reception. The action of the reflector is to destroy the omni-directional characteristics of the dipole and re-distribute its effectiveness of response at various angles over the azimuthal plane. In certain directions it is theoretically doubled whilst in others, it is reduced to zero. Owing to the proximity of the earth, however, a reduction of signal strength to zero is never possible, and it is not usual to exceed a ratio of ten to one in practice.

## Reflectors

The mechanism of the effect of the reflector may be better understood by considering Fig. 3 (a) and (b). When the dipole and reflector plane coincides with the transmission path the EMF induced in the reflector is not in the same time phase as that produced in the dipole. If, for example, the reflector is nearer to the transmitter, and is spaced one-quarter of a wavelength from the dipole, as in Fig. 3 (a) its developed EMF occurs exactly one-quarter of a cycle earlier than that developed in the dipole. Now the reflector is a continuous half-wave conductor, and thereby current flows through it and is of opposite phase to the signal field which produces it. Hence the net result at the dipole is that of the action of two fields in contrary

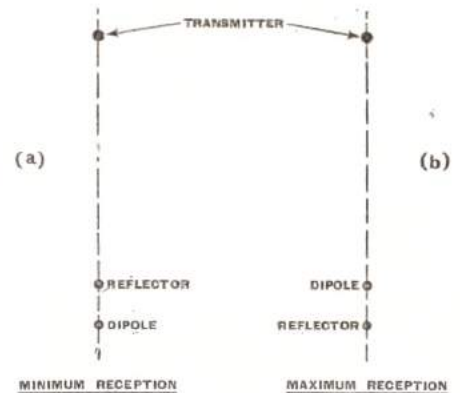

Fig. 3.—Disposition of dipole-reflector plane, and of the relative positions of dipole and reflector with respect to transmitter, to produce maximum and minimum signal strength.

**Ultra-short-wave Aerial Systems—** phase, resulting in the production of zero EMF.

When the elements are reversed so that the dipole is nearest to the transmitter, as in Fig. 3 (b), the reflector generates its current one-quarter of a cycle later than the dipole, but the secondary field from the reflector is in phase opposition, and must travel in the reverse direction to actuate the dipole, thus adding a further

important and not generally appreciated point—the *polar distribution at the resonant frequency may differ very considerably from that obtained by the same aerial system*

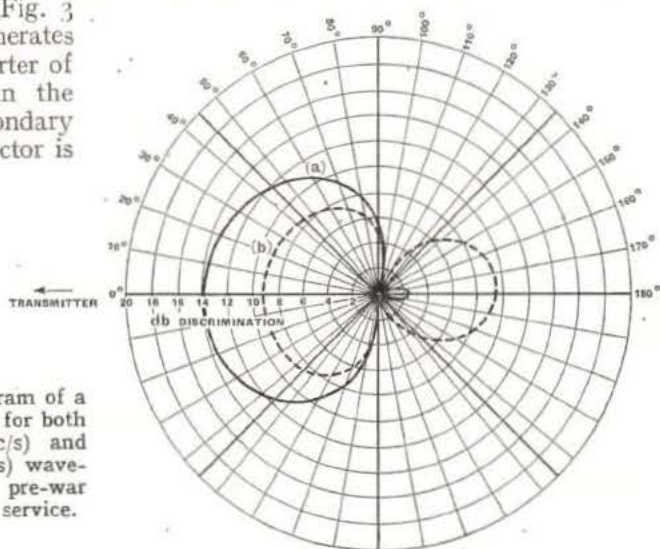

Fig. 4.—Polar diagram of a dipole and reflector for both (a) vision (45 Mc/s) and (b) sound (41 Mc/s) wavelengths of the pre-war London television service.

delay of one-quarter cycle owing to the spacing between them. Hence the nett result is that the reflector field lags one cycle behind that existing close to the dipole so that the EMFs are in phase and accordingly doubled. It follows that proportionate values must exist for intermediate positions of the reflector and dipole planes with regard to the direction of the transmitter.

### DF Properties

When one plots a graph of the response of an aerial system as a function of its directional bearing upon a transmission, the resultant curve is generally referred to as the polar response of the aerial system. This may be given for both the vertical and horizontal planes, but for our purposes it is at present only essential to consider the characteristics fully in the horizontal (azimuthal) plane. For one-quarter wavelength spacing between the reflector and the dipole this polar curve is theoretically heartshaped, and is usually termed a cardioid. In practice, however, departures occur and it is not unusual to obtain a curve possessing two fairly sharp minima with a small rear lobe whereas in theory only the single minimum should exist.

Furthermore—and this is a very

at a frequency spaced a few megacycles away. The reason for this effect is due to the fact that the aerial, because it is a simple resonant system, cannot be in resonance with both frequencies at once, so that it must behave reactively for the frequency most removed from its resonant frequency. Because of this reactive effect the phase of the reflector field is shifted slightly in addition to the phase change provided by the spacing between the dipole and the reflector.

Now the directional characteristics of the system are determined purely by these phase differences, so that if they are not identical for two spaced frequencies, one would naturally expect the polar response to differ likewise, and this is what happens in practice. As a result of this interesting property of a resonant aerial system designed to work at two fairly adjacent frequencies, we obtain typical polar responses for vision and sound respectively as shown in Fig. 4 (a) and (b). Such behaviour is to be expected whenever USW directional aerials are used for more than one frequency, particularly if the separation is fairly wide.

From a constructional viewpoint, the dipole and reflector are usually mounted on a common crossbar which, for the purpose of durability and strength may be made of metal.

The dipole elements are mounted in or on a suitable insulator, and terminals are provided for connection to the feeder line which feeds the signal to the receiver. With regard to the attachment of the reflector to the crossbar, it is not essential that this should be insulated at the point of junction, which is at the centre of the reflector. The reason for this is that the centre of the reflector is at earth potential with respect to its upper and lower extremities. This enables the insulator to be dispensed with<sup>1</sup>, and thereby provides greater strength at the point of attachment, together with an obvious economy in materials.

### Dual Purpose Aerials

In these circumstances the bar, together with its electrically connected reflector, may be used as a loading capacity for a vertical aerial of simple or anti-interference con-

<sup>1</sup> British Patent Application, 28635/38.

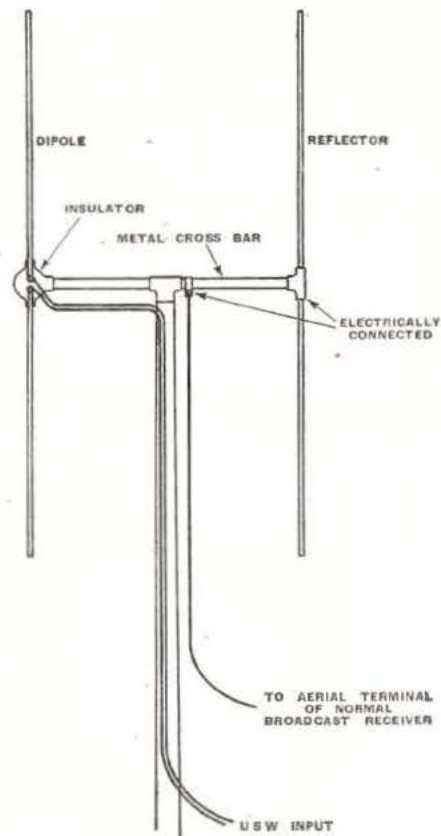

Fig. 5.—Method of using dipole both for USW and for medium and long wave reception.

**Ultra-short-wave Aerial Systems—**struction<sup>2</sup> thereby enabling the USW system to serve a dual purpose.

The crossbar and reflector so used may be made to operate a normal broadcast receiver, while the dipole and reflector at the same time will operate an USW receiver, there being no observable mutual reaction between the two. Fig. 5 shows a

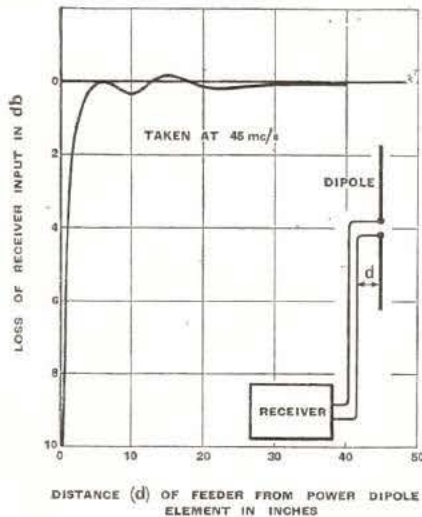

Fig. 6.—Effect on signal strength of running feeder line parallel and in close proximity to lower limb of dipole.

typical arrangement utilising this principle and is self explanatory.

An ultra-short-wave aerial system is connected to its receiver by means of a feeder line which is nothing at all mysterious, and consists of a pair of conductors laid side by side (twin line) or coaxially disposed (coaxial line). Their spacing is so arranged that they exhibit a surge impedance which matches fairly closely the radiation resistance of the aerial which, as previously stated, is of the order of 80 ohms.

### Mismatching

Serious mismatching of this line at the receiver end will lead to reduced input voltage, and in extreme cases to the introduction of frequency distortion, particularly for certain critical lengths of feeder line. These effects would cause a reduction of the vision fidelity of reproduction in the case of television.

Many loose statements have been

<sup>2</sup> British Patent Application, 27873/38.

made regarding the effects of the feeder line upon the aerial when it is not run at right angles from it, but is led away a small distance and then disposed parallel with the lower elements of the dipole as shown in Fig. 5. In this respect it will be interesting to examine the curve of Fig. 6, which shows the effect on the receiver input voltage of reducing the distance between the lower limb of the dipole and the feeder. It is quite clear that, providing this distance is not less than 10 inches, the differences are of a negligible order and only become serious when the transmission line is a few inches from the lower element. It is therefore permissible and certainly highly convenient to dispose the feeder line along the crossbar and then attach it to the mast itself for the remainder of the run.

## The Wireless Industry

A NEW "all dry" battery portable has been introduced by The Marconi-Phone Co., Ltd. This is the Model 891 at £8 10s. 6d. Four 1.4-volt valves are used in a superheterodyne circuit, and the specification includes a moisture-proof frame aerial, automatic grid bias and a special lightweight loud speaker.

Details have recently been issued by Marconi-Ekco Instruments, Ltd., Knoll Cottage, Gills Hill, Radlett, Herts, of an inexpensive beat frequency oscillator (Type 692) with a range of 50-12,000 c/s, and an audio frequency micro-volter" (Type TF620). The latter is a monitored attenuator for providing a calibrated source of AF voltage.

We have received from Webb's Radio, 14, Soho Street, London, W.1, an illustrated pamphlet describing the Hallcrafters "Champion" and SX17 receivers. Copies will be sent to any reader who cares to apply to the above address.

Watford Instruments (Paul D. Tyers), 7, Devereux Drive, Watford, have issued a 1940 list and price schedule of communication and allied measuring instruments. These include signal generators, beat oscillators, multivibrators and oscilloscopes.

The Type R.502 wavemeter for general laboratory and field use is described in a leaflet just issued by Standard Telephones and Cables, Ltd., Oakleigh Road, New Southgate, London, N.11. The range is 6.5 to 3,000 metres, and indication is given by a microammeter in conjunction with a diode rectifier.

## The "Fluxite Quins" at work



*Cried Oo, "What a beautiful tone  
Not a whisper of crackle or groan."  
"Yes, my dear," replied Eh,  
"There is only one way  
To fix wiring. FLUXITE stands alone."*

See that FLUXITE is always by you—in the house—garage—workshop—wherever speedy soldering is needed. Used for 30 years in government works and by leading engineers and manufacturers. Of Ironmongers—in tins, 4d., 8d., 1/4 and 2/8.

Ask to see the FLUXITE SMALL-SPACE SOLDERING SET—compact but substantial—complete with full instructions, 7/6.

Write for Free Book on the art of "soft" soldering and ask for Leaflet on CASE-HARDENING STEEL and TEMPERING TOOLS with FLUXITE.

*TO CYCLISTS! Your wheels will NOT keep round and true unless the spokes are tied with fine wire at the crossings AND SOLDERED. This makes a much stronger wheel. It's simple—with FLUXITE—but IMPORTANT.*

## THE FLUXITE GUN

is always ready to put Fluxite on the soldering job instantly. A little pressure places the right quantity on the right spot and one charging lasts for ages. Price 1/6, or filled 2/6.

FLUXITE LTD.  
(Dept. W.W.),  
DRAGON WORKS,  
BERMONDSEY  
STREET, S.E.1

ALL MECHANICS WILL HAVE

# FLUXITE

IT SIMPLIFIES ALL SOLDERING

# Fault Finding by Signal Tracing

## DISCUSSION OF A NEW AMERICAN SYSTEM

**M**ETHODS of finding faults in receivers are always of interest, and this is especially so when they promise a more speedy or a more certain solution of the serviceman's problems. A system which has achieved some prominence in America recently is known as Signal Tracing, and it is fully described in a book entitled "Servicing by Signal Tracing," by John F. Rider.<sup>1</sup>

The author divides servicing methods into two classes. According to his classification, the general method consists of steady voltage and current tests with the receiver in operation, supplemented by resistance checks with an ohmmeter when the receiver is switched off. He rightly points out that such tests are incomplete and leave many components unchecked, so that it is possible for faults to exist which cannot be revealed by such tests.

The second method of testing is by signal tracing. In this no attention is paid to steady voltages or currents, beyond seeing that no overheating is occurring, nor to circuit resistance. Instead, a signal is injected into the aerial circuit, and fault finding is accomplished by checking its magnitude and frequency at many points through the receiver.

For this checking a special instrument is required, and this is a voltmeter which is sensitive enough to respond to inputs of the order of a few microvolts, which has a substantially infinite input impedance, and which is frequency selective so that it responds only to a narrow band of frequencies. It must naturally be tunable so that it can be used at any desired frequency. This is certainly a most unusual instrument, and we shall have more to say about it later,

but for the moment let us imagine that we possess such an instrument.

In checking a receiver—say, a superheterodyne—we apply a modulated RF input to the aerial and earth terminals from a modulated test oscillator, adjusting the input to a normal figure for the receiver. Testing is then carried out by measuring the RF, IF and AF voltages at all points in the set. The input voltage itself can be checked, the voltage on the grid of the first valve and on its anode circuit and the frequency of the RF signal. The oscillator can be treated independently in a similar manner, and the check on its fre-

quency is valuable as affording an indication of the accuracy of the ganging, since it will normally be higher than the input signal by an amount equal to the intermediate frequency.

resistance of a normal RF stage, and an appreciable voltage is indicated, it is fairly definite that the by-pass condenser has developed an open circuit, as there should be a negligible RF voltage at this point. In order to make full use of the method, it is naturally desirable to have information on the magnitudes of the voltage which should exist at all the testing points. This is rarely available, since few, if any, manufacturers supply such information about their products. The absence of this data, however, does not mean that the system is useless, for a little experience and knowledge of modern receiver practice will enable the user to judge the condition of the various stages with reasonable accuracy. He will, for instance, be able to judge whether the stage gain, shown by the ratio of the voltages on the grids of successive valves, is normal or not.

The main purpose of the method is to localise the fault in a particular stage in the receiver, although in certain cases it will go farther than this, and show which component is defective.

Having tracked down the fault to a particular stage, other methods are employed to find its precise location; voltages and currents to the valve are checked and measurements of circuit resistance are made.

In addition to the foregoing, use is also made of a voltmeter for unidirectional voltages which is unaffected by the presence of superimposed alternating voltages. This is a fairly simple instrument, and consists essentially of a valve voltmeter adapted for DC measurements and provided with an input filter to remove alternating components. With the aid of this, diode circuits and AVC systems can readily be checked.

The RF voltmeter is a far more

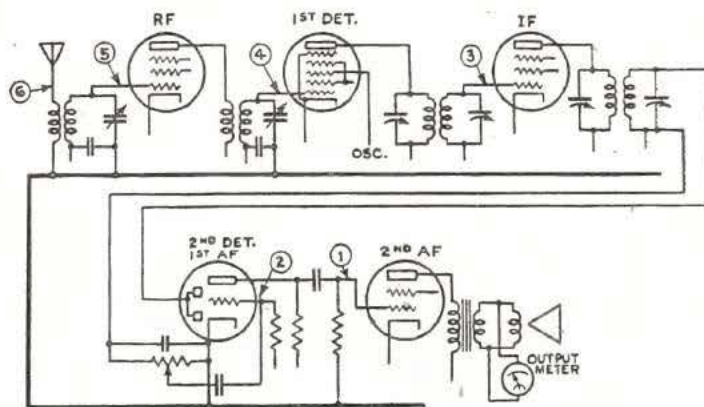

A simplified skeleton diagram, reproduced from "Servicing by Signal Tracing," which shows the application of the principle to a typical superhet.

<sup>1</sup> Pp. 360 and xi. Price \$2.00. Published by John F. Rider, 404 Fourth Avenue, New York City, U.S.A.

**Fault Finding by Signal Tracing—**

elaborate piece of apparatus, and consists essentially of a high gain tuned RF amplifier, a diode detector and a cathode-ray tuning indicator. The input is applied with the aid of a probe and screened cable, and the actual feed is through a condenser of 1.5  $\mu\mu\text{F}$  capacity built into the probe, so that the input capacity of the instrument does not exceed this figure. Different voltage ranges are provided by an input attenuator of the capacity type in conjunction with a variable control of grid bias on the first valve.

The difficulties in the design of such an amplifier are considerable, for it is clearly desirable that the gain should be independent of the frequency to which it is tuned, and it is also desirable that it should be constant from day to day. For a wide frequency range and a high gain the difficulties are very considerable, but an instrument designed for this purpose is being manufactured commercially under the name Chanalyst.

There can be no doubt whatever that this method of fault finding is a satisfactory one. Given the necessary special apparatus, any normal defect should readily be traced. There is also no room for doubt that signal-tracing methods are superior to voltage, current and resistance tests as a sole method of servicing. One is inclined to doubt, however, if anyone uses simple measurement as his only method of fault finding. It seems more likely that the majority of those engaged in servicing already use some system of signal tracing.

In general, an output meter is used as an indicator, and the output

of an AF oscillator or RF test oscillator is applied in turn to the various stages, starting at the output and working backwards towards the aerial. The complete process is not always followed, of course, for preliminary tests on an aerial often indicate roughly where the fault lies. For instance, it may be clear that the AF circuits are in order, and stage-by-stage testing is then naturally started in the IF amplifier.

Direct tests on signals of by-pass condensers are less readily made by this method, it is true, but it would seem to be as good as the new one for dealing with the main signal circuits themselves. The new method, which we feel can have no exclusive claims to the title of signal tracing, has certain definite advantages over the more widely used system in that it permits a more ready check of certain components. It does demand more complex apparatus, however, and it is consequently for the individual to decide whether the advantages justify the use of this more elaborate gear.

Briefly, then, the new method consists of applying a certain signal to the input and checking its magnitude throughout the set with a suitable voltmeter. The older system is to use an output meter and apply varying signals in turn to the necessary points in the receiver, the inputs at these points being adjusted for constant output. One method is thus the inverse of the other.

**G.E.C. "All-dry" Battery Portable**

THE recently introduced Model BC4141 is designed to stand up to the kind of handling to which sets of this type must expect to be subjected. The chassis is strongly made and the components are mounted on rubber shock absorbers. After removing two screws from the side, the case can be lifted completely from the base, giving access to the batteries and chassis. The overall dimensions of the set are 11 $\frac{1}{2}$ in. by 12 $\frac{1}{2}$ in. by 7 $\frac{3}{8}$ in., and the price is £8 18s. 6d.

A self-contained frame aerial is fitted and the circuit is a 4-valve superheterodyne which feeds a 6 $\frac{1}{2}$ in. moving coil loud speaker.

Connection to the combined HT and LT battery is through a non-reversible 4-pin plug and socket.



G.E.C. "All-dry" battery portable Model BC4141.

**BULGIN**

for  
**SWITCHES**

The Bulgin range of switches comprises over 130 different models: mains, toggle, rotary and push-button. These switches are known everywhere for reliability and exceptionally Q.M.B. action. The small rotary and mains switches can be used for practically every radio and electrical need.

The Rotary wave-change switches constitute some of the most advanced types available, and it is possible to assemble almost any combination desired. The Rotary midget selector switches also have an enviable reputation, and the uses to which these switches may be put are considerable.

ALL PRICES SUBJECT

List No.	Max. Volts	Price
S.45	32	4½d.
M.P.1/3	100	1/-
S.39	32	1/-
S.113	32	1/-
S.117	32	1/3
S.36	32	1/6
S.81.T	250	1/9
S.184	250	1/9
S.176	250	2/-
S.180	250	2/-
S.185	250	2/-
S.80.B	250	2/3
S.114	250	2/3
S.129	250	2/6
S.220	32	2/6
S.186	250	2/6
S.230	250	2/6
S.116	250	2/9
S.200 (R)	250	2/9
S.205 (R)	250	3/9
S.243/8 (R)	250	4/-
S.221/6 (R)	250	5/6
S.227/33 (R)	250	6/6

(R) denotes Rotary Type  
PLUS 10% WAR INCREASE

**RADIO SERVICE MANUAL**  
Write for this New Manual with its 280 pictorial and theoretical diagrams and clear concise text. Solves your problems.

1/-  
post free.

FOR ALL RADIO  
**COMPONENTS**

Advert. of A. F. Bulgin & Co., Ltd., Abbey Road, Barking. Tel.: RIPPleway 3474

# Random Radiations

Sorry, But . . .

A READER stationed in a Yorkshire camp is probably wondering why he hasn't had a reply from me to a recent letter of his. The reason is that I was completely unable to read his signature. Had I been at home instead of "somewhere in England," I could have turned up previous correspondence; as it is, I have no files with me and can't for the life of me recall the name that fits the cryptic signature. This is sure to meet his eye, for he is an ardent reader of *The Wireless World*. Will he please send me a postcard revealing his identity?

■ ■ ■

## Cut-Price Licences?

SOME folk seem to think that as the B.B.C.'s activities have been curtailed under war conditions, the price of the receiving licence should be reduced. They argue that the B.B.C. isn't spending half what it did on its programmes; so why should the

By "DIALLIST"

listener make his full contribution? It has been pointed out often enough in *The Wireless World* that the licence fee is paid for the right to install and operate a receiving set: it does not automatically entitle its purchaser to have programmes provided for him—any more than the 7s. 6d. paid for a dog-licence entitles the licensee to be provided with a dog! Actually, the grant made by the Government to the B.B.C. is calculated as a percentage of the amount received for licence fees, but that does not affect the question. The grant has been reduced, it's true; but when the war is over there will be huge calls for the renovation of existing stations and for the erection of new ones. The Government, with an eye to the future, needs the whole of the ten shillings. There won't be any reduction—nor do I think that there will be any increase—in the price, though some have forecast this.

## The Troops Like Them

THAT splendid institution, the Nuffield Trust, is doing noble work in providing wireless sets for the troops. Ours has at last turned up, and I hear it going morning, noon and night. It is a portable of the all-dry type. If it continues to be worked as hard as it is now, I'm afraid that its battery won't last long! I shall have to arrange for all and sundry to contribute their mite each week to a replacement fund. They won't mind doing that, for in a forsaken spot like this a wireless set is a priceless boon. The time when it's most appreciated is in the evening, for in the living quarters our only form of illumination is the horrible oil lamp—and not very many of them. There's not light enough to read by without putting a strain on the eyes. Before the wireless set came things were pretty dull after lighting-up time. Now life is much more worth living, and the troops are more than grateful to the Trust.

■ ■ ■

## Runbaken Magazine Soldering Iron

AN ELECTRICALLY HEATED IRON WITH AUTOMATIC FEED

IN repetition work much time is lost in cleaning and tinning the bit when an ordinary iron is used, and the Runbaken iron should therefore be of special interest to those responsible for the reduction of operating costs.

The solder, which is obtainable with either a resin or an acid core, is in the form of wire and is wound on a spool at

without feeding it forward. Normally, there is a gap of  $\frac{1}{2}$  inch between the solder and the bit, which is ample for introducing a file for cleaning the bit.

It would appear that the iron is best suited for the wiring of components and sub-assemblies, but it can also be used for wiring inside sets provided there is an approach to the joint measuring approximately  $1\frac{1}{2}$  in. by  $\frac{3}{4}$  in. The continuous solder feed is ideal for long joints in metal screens, etc.

Runbaken Type No. 1177 automatic soldering iron.

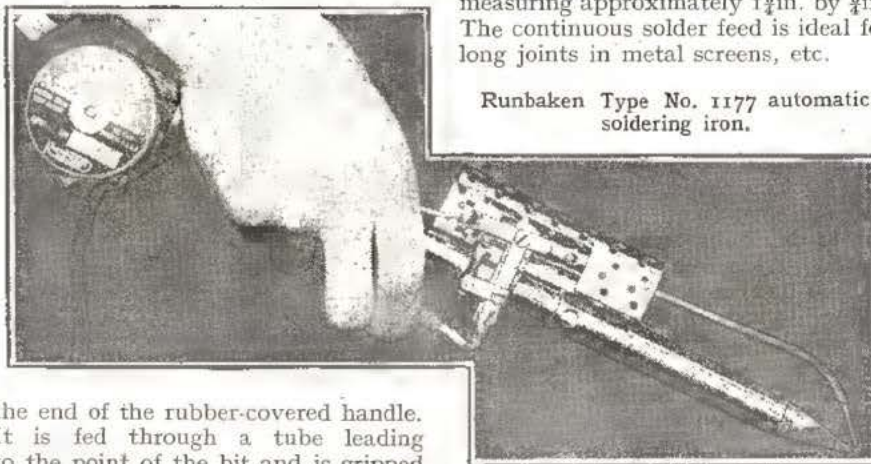

the end of the rubber-covered handle. It is fed through a tube leading to the point of the bit and is gripped by a chuck and forced forward about  $\frac{1}{16}$  inch every time the trigger is pressed hard. Light pressure on the trigger touches the solder on the iron

The current price is £4 6s. 3d., and the makers are Runbaken Electrical Products, 13-15, Liverpool Road, Manchester, 3.

## No Television Yet

AS I predicted, the authorities turned down the suggestion that the television service from Alexandra Palace should be restarted. Now that those who instigated the movement for the restoration of the service know that there are good and sufficient reasons for A.P.'s remaining dumb, I hope that they will be content to take no for an answer and won't go on badgering the P.M.G. Something might perhaps be done about wired television if the G.P.O. had sufficient skilled men available for its development. I don't think that it has, though. Large numbers of Post Office engineers, linesmen and so on have joined up in one or other of the fighting forces, and those left can't do much more than cope with the work that comes their way in the ordinary course of events in maintaining and developing the telephone and telegraph services.

■ ■ ■

## Echoes

LATELY I've been hearing some wonderful echoes down near the bottom of the short-wave band—or up near the top of the megacycles, if you so prefer it. Some of the best that I've come across for a long time were on one or other of the Daventry trans-

## VALVE DATA NEXT MONTH'S ISSUE

AS regular readers will be aware, it has been the custom of *The Wireless World* to publish once a year a VALVE DATA SUPPLEMENT giving a list of receiving valves with details of their characteristics, base connections and other information.

Unfortunately, the cost of printing this information, quite apart from the work involved in its preparation, has made it impossible for this feature to be continued as an editorial supplement in wartime.

However, when this was explained to valve manufacturers they came forward with the proposal to include such information in the advertisement pages rather than that readers should be deprived of the feature to which they had been accustomed and which is kept for constant reference throughout the year.

Next month's issue will therefore contain Valve Data as usual, but the form of presentation will be different as each manufacturer's valves will be listed separately. In many respects this form will be found more convenient.

There is likely to be an unusually big demand for the issue, so that it would be well for readers to have their copies reserved in advance.

missions; on one occasion there was a distinct *triple* echo; you could count the repetitions quite easily when a pause occurred at the end of a sentence. When I came across that one I had a fellow with me who had never before heard a short-wave echo—he heard that one all right! "Back he came" sounded like "b-b-b-back h-h-he came-ame-ame-ame."

### Oh, For More Time!

My only wish is that I had more time to make use of my short-wave receiver, for conditions have been very interesting for some little time now. I've mentioned that we have no electric light in our living quarters—so I can't use the set (a communication receiver) there. But there's all the AC juice one could want at the scene of my activities and the set is installed there. But I have so little time to spare when I'm not in bed that if I do bring the set into use I have to remove the bats' nests and cobwebs that have accumulated since the last time before I can start twiddling the knobs. And then, just as I've struck something interesting, along comes a job of work, and I have to switch off with a groan. We're promised electric light in the mess; actually, it's been "coming along in about ten days" for rather more than four months. The overhead cables run within a few yards of us, and most of the internal wiring is already done, but for some red-tapy reason no one seems to be authorised

to supply that missing link of line between our hut and the supply cable.

### Towards the Sunspot Minimum

Luckless wights like myself realise that they are missing the interesting transitional period as we leave the sunspot maximum further and further behind, and travel towards the minimum period, which should be due in from three to five years' time. This time last year, when big sunspot groups were constantly appearing, when there were brilliant displays of the Aurora Borealis, and when terrific magnetic disturbances took place at intervals, I'd promised myself a thrilling time in the first five months of 1940. I've certainly had a few thrills, but few of them have been of the radio order! And when it comes to short-wave wireless, even if you can use your set, half the fun is gone when you can't get magnetic or sunspot data. I long for the time when it will once more be possible to get hold of such information and to read of the experiences of other enthusiasts before they're so stale as to be of little use.

### Working in the Dark

Perhaps I shouldn't have said "of little use," for the experiences recorded in the logs of enthusiasts will always be useful. What I meant was that if nowadays you find conditions puzzling, you can't discover quickly

## VORTEXION 50w. AMPLIFIER CHASSIS

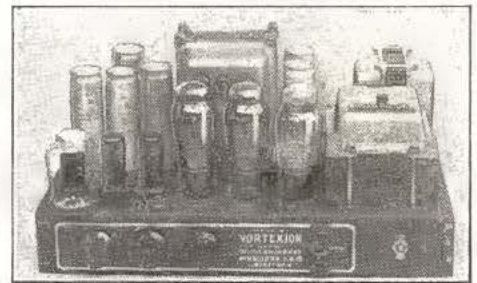

A pair of matched 6L6's with 10 per cent. negative feed-back is fitted in the output stage, and the separate HT supplies to the anode and screen have better than 4 per cent. regulation, while a separate rectifier provides bias.

The 6L6's are driven by a 6FG triode connected through a driver transformer incorporating feedback. This is preceded by a 6N7, electronic mixing for pick-up and microphone. The additional 6F5 operating as first stage on microphone only is suitable for any microphone. A tone control is fitted, and the large eight-section output transformer is available in three types:—2.5-15-30 ohms; 4-15-30-50 ohms or 15-50-125-250 ohms. These output lines can be matched using all sections of windings and will deliver the full response (40-18,000 c/s) to the loudspeakers with extremely low overall harmonic distortion.

CHASSIS with valves and plugs ..... £17 10 0  
Or complete in black leatherette cabinet with Collaro taratula, Piezo P.U. and shielded Mike Transformer ..... £22 10 0  
Goodmans P.A. Speakers in stock.

Resio Horns ..... £11 11 0

Resio M.C. Microphones ..... £3 15 0

Amperite Ribbon Microphones from ..... £5 5 0

All P.A. and A.R.P. Warning Gear in stock.

Many hundreds already in use for  
A.R.P. & GOVERNMENT purposes

## 15w. AC & 12-VOLT DC AMPLIFIER

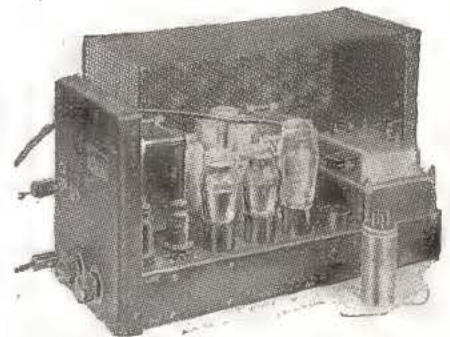

Type CP20

This small Portable Amplifier, operating either from AC mains or 12-volt battery, was tested by *THE WIRELESS WORLD*, October 1st, 1937, and has proved so popular that at Customers' demand it remains unaltered except that the output has been increased to 17.2 watts and the battery consumption lowered to 6 amperes. Read what *"The Wireless World"* said:—

"During tests an output of 14.7 watts was obtained without any trace of distortion so that the rating of 15 watts is quite justified. The measured response shows an upper limit of 15,000 c/s and a lower of 30 c/s. Its performance is exceptionally good. Another outstanding feature is its exceptionally low hum level when AC operated even without an earth connection. In order to obtain the maximum undistorted output, an input to the microphone jack of 0.037 volt was required. The two independent volume controls enable one to adjust the gain of the amplifier for the same power output from both sources, as well as superimpose one on the other, or fade out one and bring the other up to full volume. The secondary of the output transformer is tapped for loudspeakers of line impedances of 4, 7.5 and 15 ohms."

AC and 12-volt CHASSIS with valves, etc. .... £12 12 0

Or in Rexine Case with Collaro Motor, Piezo P.U. and Mike Transformer ..... £17 17 0

AC only CHASSIS with valves, etc. .... £8 18 6

Or in Rexine Case with Collaro Motor, Piezo P.U. and Mike Transformer ..... £14 0 0

Genzo Case for either chassis 12/6 extra.

Write for Illustrated Catalogue.

Vortexion Ltd., 182, The Broadway,  
Wimbledon, S.W.19. Phone: LIBerty 2814.

Random Radiations—

whether others in different places are faring similarly. If you find a partial or complete black-out you begin to wonder whether your equipment isn't at fault. In normal times your morning paper often sets your mind at rest by recording a magnetic storm; or if it doesn't you're pretty sure to find what you want to know from a technical journal within a short time. Now you have to wait ages before you can get the information. Well, I suppose that the restoration of the old facilities when things return to normal will be such a joy that we old hands will return to unhampered short-wave wireless with the zest of schoolboys. You remember the fellow who used to walk about with his shoes full of dried peas in order to enjoy the acute pleasure that he felt when he took them off? Perhaps we'll have similar feelings when we're able once more to get up-to-date information about reception conditions.

Network Television

THE American G.E.C.'s recent feat in relaying a television broadcast from New York to Schenectady, a distance of well over 100 miles, was a

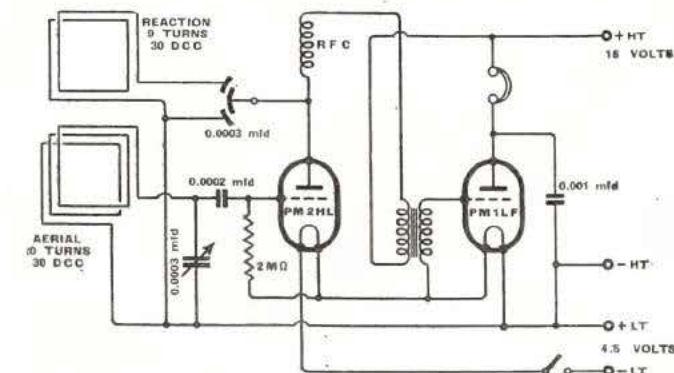

fine achievement. The sound-and-vision programme transmitted from New York on the 44-50 megacycle band was picked up by a station on the heights of the Helderberg Mountains. This station is some 12 miles from the main transmitter, situated also in the mountains. From the relay the vision signals are passed by a 10-watt (!) transmitter on the 156-162-Mc/s band to the main station; thence they go out with 10 kilowatts behind them on the 66-72-Mc/s band. The sound portion of the transmission goes over the landline from relay to main transmitter. Despite the rather complicated nature of the process and the fact that the vision signals were twice received and transmitted on changed frequencies, it is stated that final reception did not suffer.

Miniature Portable  
COMPACT HOME-BUILT  
RECEIVER

THE opinion was recently expressed in this journal that wartime conditions might sometimes compel us to "put back the clock," and to revert to simple wireless devices and circuits that have been out of fashion for many years. A typical example of this tendency is to be found in ultra-light-weight broadcast receivers for use on active service or under similar conditions brought about by the war. For such sets the classical detector-AF circuit has special attractions; indeed, without special valves and components, there is hardly an alternative.

In the accompanying illustrations is shown a set of this type which, in spite of the simplicity of its circuit, has a performance adequate for its purpose. Built by a reader, Mr. R. A. Coates, the receiver employs two 0.1-amp. valves with filaments wired in series and fed from a 4½-volt dry battery. HT is derived from two 9-volt grid-bias batteries in series. Frame aerial and reaction coils are wound on a framework measuring about 9in. by 8½in. Both windings are made with No. 30 SWG DCC wire, adjacent turns touching, while a spacing of ¼in. is allowed between sections.

Of course, a set of this nature is in-

tended solely for headphone listening, and in the original model connection of the phones is made through a jack, which also controls the filament circuit switching. This detail is not shown



in the accompanying circuit diagram. Thanks largely to smooth reaction control, the little set is surprisingly sensitive, and provides good signals under the most unpromising receiving conditions.

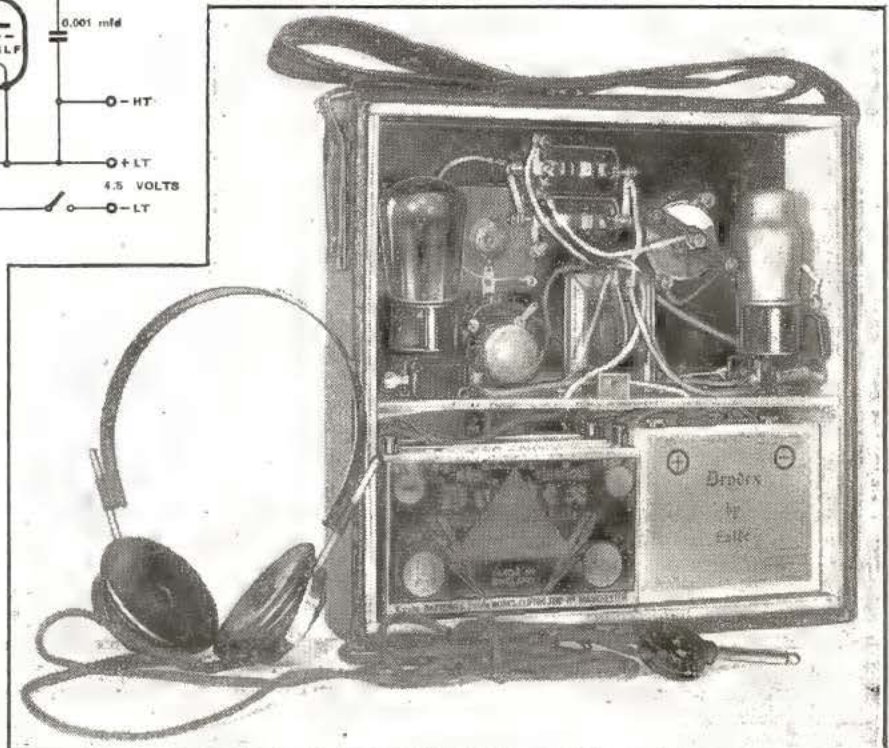



# Recent Inventions

Brief descriptions of the more interesting radio devices and developments disclosed in Patent Specifications will be included in these columns

## TUNING IMPROVEMENTS

**T**UNING over the range from 200 to 580 and 696 to 2,000 metres is effected by means of a single condenser and two coaxial coils, the change-over from one coil to the other taking place automatically at a given setting of the condenser. By adding a third coaxial coil, the wave-range can similarly be extended to include the short waveband from 15 to 60 metres.

The effective inductance of each of the coils is uniformly varied by means of a powdered-iron core, which is automatically shifted along the common axis of the coils by the movement of the tuning condenser. At the beginning of each waveband, the inductance of each coil is inherently tuned to the shortest wavelength in that band. The arrangement gives an approximately straight-line frequency division of the tuning scale.

*R. Bosch G.m.b.h. Convention date (Germany), April 29th, 1937. No. 514213.*

o o o o

## TELEVISION IMPROVEMENT

**T**HE valves which amplify the picture signals in a television broadcast system are called upon to handle a very wide frequency band, say, between one and two megacycles, whilst the amplifiers for the associated sound signals are limited to a frequency band not exceeding 10,000 cycles per second.

The object of the invention is to distribute the total frequency band more evenly between the two sets of amplifiers, so as to overcome the present difficulty of dealing faithfully with the wide spread of the picture signals.

For this purpose the visual signals are sub-divided into two bands of substantially equal width, and the lower band is superposed on one carrier wave. The upper band is first heterodyned so as to shift its frequency down to that of the lower half, and a band of frequencies equal to 10,000 cycles is abstracted from it. It is then superposed, together with the sound frequencies, on the second carrier wave. In reception the process is reversed.

*Marconi's Wireless Telegraph Co., Ltd., and L. E. Q. Walker. Application date, March 14th, 1938. No. 512571.*

The British abstracts published here are prepared with the permission of the Controller of H.M. Stationery Office, from specifications obtainable at the Patent Office, 425, (Southampton Buildings, London, W.C.2, price 1/- each.

## AUTOMATIC FREQUENCY CONTROL

**I**N a wireless receiver with automatic tuning control, it is desirable that the amount by which the local oscillator is "shifted," to bring the circuits into line, should be approximately constant at all wavelengths, irrespective, that is to say, of the particular station to which the set is being tuned.

The figure shows a superhet circuit comprising RF amplifier A, a mixer stage M coupled to a local oscillator valve LO and IF amplifier V, and a discriminator circuit D of any known type. The latter develops the ATC voltage, which is fed to the grid of a control valve V1 shunted across the local-oscillator circuit.

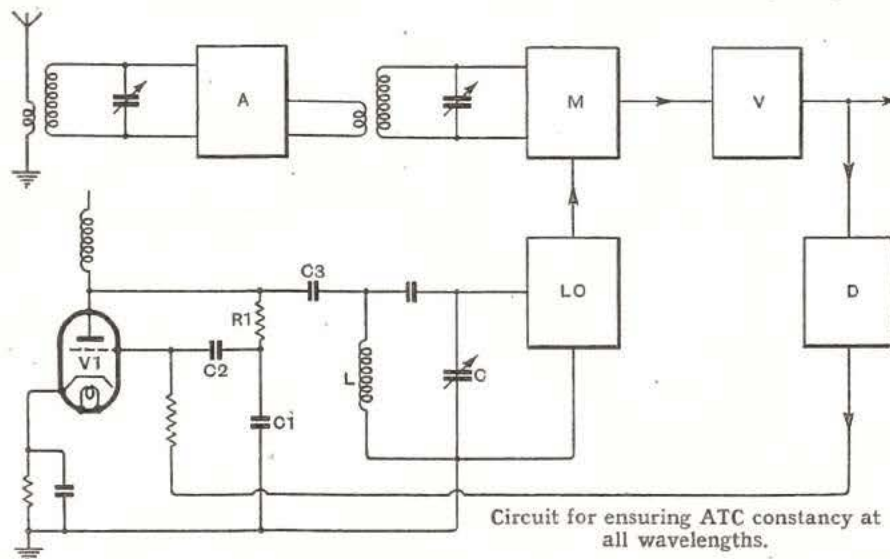

Circuit for ensuring ATC constancy at all wavelengths.

The plate circuit of the control valve includes a resistance R1 in series with a condenser C1, whilst the grid is connected through a condenser C2 to a point between them as shown. If the value of the coupling condenser C3 is made such that in combination with the inductance L it is resonant to a frequency below that of the tank circuit LC, the percentage frequency shift of the tank circuit will vary inversely with the tuning frequency. This serves to level up the frequency shift which is applied by the ATC voltage at all points of the tuning scale.

*Marconi's Wireless Telegraph Co., Ltd. (assignees of D. E. Foster). Convention date (U.S.A.), April 10th, 1937. No. 513449.*

o o o o

## LARGER TELEVISION PICTURES

**R**ELATES to a television receiver of the kind in which the picture is reproduced, not on the fluorescent screen of a cathode-ray tube, but on a screen

which is located outside the tube, so that it is not restricted in size by the dimensions of the tube.

The invention is based upon the use of a system of cartesian co-ordinates in order to locate each of the incoming picture signals in its proper position upon the external viewing screen.

For this purpose the fluorescent screen of a cathode-ray tube is replaced by two separate wire grids or gratings located close together, but so that the wires in one grating are set at right-angles to the wires in the other grating. These represent the two sets of co-ordinates, the ends of all the wires being taken outside the wall of the tube. The gratings are

scanned by the electron stream from the gun of the tube in the ordinary way, but the electric charges received by each wire are led away, and used to produce corresponding light effects on the external viewing screen.

*F. A. Lindemann. Application date, April 6th, 1938. No. 513486.*

o o o o

## DIRECTIONAL AERIALS

**T**HE efficiency with which the Adcock type of aerial responds to vertically polarised waves whilst remaining unaffected by horizontally polarised waves (thus eliminating the so-called "night-effect") depends very largely upon the character of the surrounding earth. Any irregularity in the conductivity of the ground creates an asymmetrical field of force, in which horizontally polarised components are likely to be present.

To prevent such irregularities, the aerial is erected over ground which has been artificially treated to equalise its conductivity either by the use of buried

## Recent Inventions—

wires, or by impregnation with saline solution. Alternatively the aerials are erected over a reservoir containing a salt solution of uniform conductivity.

*C. Lorenz Akt. Convention date (Germany), December 20th, 1937. No. 512705.*

## TELEVISION MODULATION

THE circuit shows an electron multiplier which can be used to give up to 100 per cent. modulation as a television transmitter. The secondary-emission electrodes T<sub>1</sub> . . . T<sub>4</sub> are of the open grid type, and are not coated with sensitised material. They are biased with progressively increasing voltages tapped off

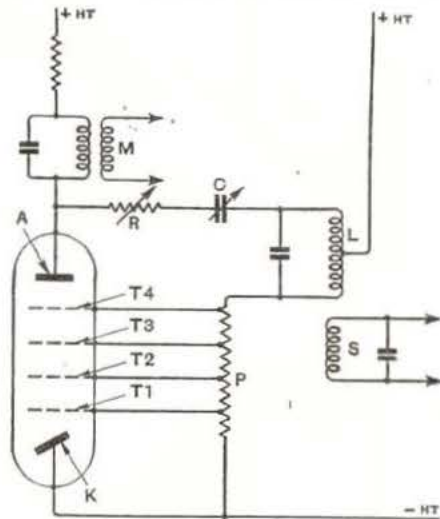

Modulating a television transmitter.

from a potentiometer P. A constant potential difference, depending upon the slope of the characteristic curve of the multiplier, is applied between the electrode T<sub>4</sub> and the anode A, and a source S of energy of carrier-wave frequency is coupled to the lower half of the centre-tapped coil L.

A light-beam of varying intensity is focused on the photo-electric cathode K and releases primary electrons, which are amplified in their passage through the electrodes T<sub>1</sub> . . . T<sub>4</sub>, and are modulated between the last-mentioned electrode and the anode A. The output is taken off at M. Any carrier-wave frequency transferred by the capacity coupling between T<sub>4</sub> and the anode A is balanced-out by the neutralising circuit formed by the upper half of the coil L, a variable resistance R, and a variable condenser C.

*G. W. Walton. Application date, December 10th, 1937. No. 514297.*

## NEGATIVE FEEDBACK

IT is often desirable, for reasons of convenience and simplicity, to apply negative feedback to an amplifier through a transformer coupling which, to ensure a good frequency response, should have a considerable number of primary turns, the primary and secondary being wound as a number of interleaved sections. Such

a transformer, however, is equivalent at high frequencies to a complex network containing a large number of reactances, and so does not lend itself to stability.

The invention is based on the fact that each section of the transformer has certain "stray" reactances, such as leakage inductance and capacity to the common core and to neighbouring sections. Accordingly, one or more additional balancing or stabilising condensers are connected in circuit in such a way as to make the transformer the equivalent of one having single primary and secondary windings. It then no longer behaves at high frequencies as a complex network but as an electrically simple circuit which is stable in operation.

*C. G. Mayo and H. D. McD. Ellis. Application date, May 6th, 1938. No. 514729.*

## FRAME AERIALS

TO save space, it may on occasion be convenient to use a frame-aerial with an edge-wound or single-layer coil, this being more efficient, electrically, than a single winding. It is, however, found difficult in this event to control the spacing of the wires, which tend to fall down past each other, and so alter the effective inductance of the aerial.

According to the invention the wires are first wound in a single layer on a strip of paper or fabric laid over a circular mandrel, as shown in (a). The windings are next coated with a quick-drying cement, and, together with the backing of paper or fabric, are removed from the mandrel. They are then folded in a jig so that they take the form shown in (b), which is a flat rectangular coil with the upper side E turned in the reverse directions to the lower side D. The wires in the two long sides may be crinkled or corrugated in order to ad-

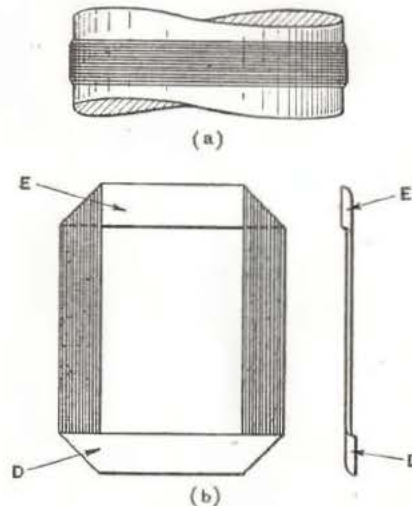

Constructing edge-wound frame aerials.

just the overall inductance of the aerial to a desired value.

*Pye, Ltd., and W. A. St. C. Smith. Application date, April 23rd, 1938. No. 513961.*

## SEPARATING SYNCHRONISING IMPULSES

LINE and frame impulses of different duration are superposed on the carrier wave, and are separated, first

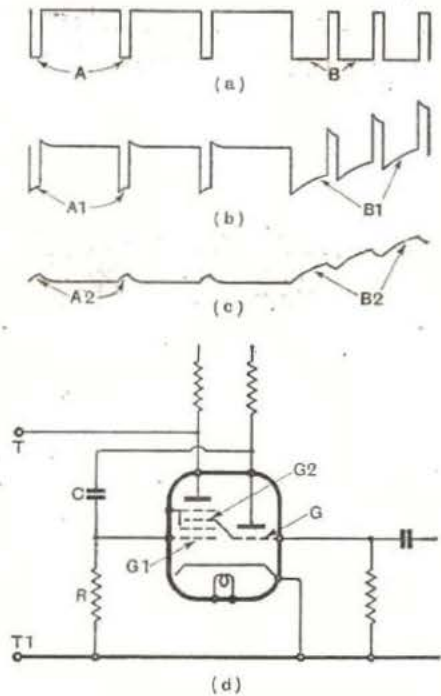

Separating line and frame signals.

from the picture signals and then from each other, by a method which depends upon converting the difference in duration into a difference of amplitude.

Fig. (a) shows the impulses as radiated, those marked A representing "lines," whilst those marked B (which are considerably longer) represent "frames." Both are, of course, superposed on the carrier wave in the opposite sense to the picture signals.

After passing through the separator valve, the impulses emerge in the form shown in Fig. (b), the impulses A now having the form A<sub>1</sub>, whilst the impulses B have the form B<sub>1</sub>, the latter showing an increased "slope" or amplitude. If the two sets of curves are superposed, in opposite phase, the result will be as shown in Fig. (c), where A<sub>2</sub> of constant amplitude represent the line impulses, whilst B<sub>2</sub> of increasing amplitude represent the frame impulses.

The mixed signals are applied to the grid G of the triode-hexode valve shown in Fig. (d), the pulses being separated from the picture signals in the usual way. The pulses are fed back to the grid G<sub>1</sub> through a capacity C and resistance R, and are thus converted into the form shown in Fig. (b). The two are mixed to produce pulses of the form shown in Fig. (c) by connecting the grid G<sub>2</sub>, and taking the output from the terminals T<sub>1</sub>.

*C. L. Faudell; R. E. Spencer; and I. J. P. James. Application date, February 4th, 1938. No. 513205.*

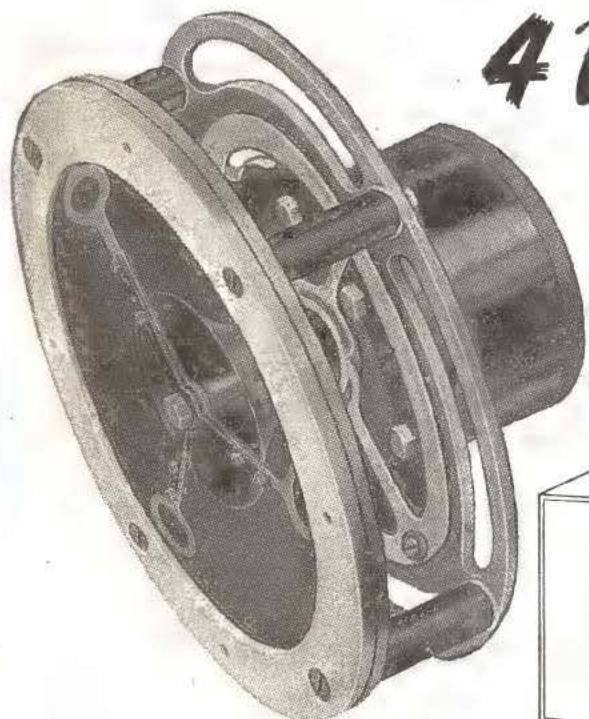

# 4 Vital Facts about GOODMANS Infinite Baffle LOUDSPEAKER

- (1) Unique diaphragm suspension ensures absence of resonance. No "colouration."
- (2) High Flux Density Magnet and light diaphragm assembly provides exceptionally good transient and high note response.
- (3) Unusually flexible suspension eliminates frequency doubling.
- (4) Entirely new and unorthodox chassis design, of extreme mechanical rigidity, ensures freedom from resonance and reflection.

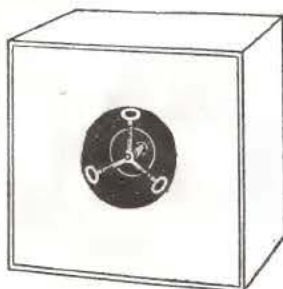

GOODMANS "Infinite Baffle" Loudspeaker makes possible in the home a fidelity of reproduction hitherto confined to the laboratory. In effect the result is that of employing a baffle not less than 8 ft. square but, adapting the principle of the "Helmholtz" resonator, Goodmans have produced a loudspeaker which is only 18" cube with a smooth and true response to the lowest audible frequency.

Post this Coupon for FREE Technical Booklet

**SPECIFICATION:** Useful frequency range 30 c.p.s. to 12,000 c.p.s.; Power Rating Capacity 15 watts A.C. Peak. Speech Coil impedance: 2.5 ohms. Weight: 42 lbs. Supplied fitted in plain loudspeaker case 18" x 18" x 18", finished grey. —£10 (Excluding Transformer)

High grade cabinets also available in various finishes.

GOODMANS INDUSTRIES LTD., Lancelot Rd., Wembley, Middx. 'Phone: WEMbley 4001 (5 lines)

To: — GOODMANS INDUSTRIES LTD., Lancelot Road, Wembley, Middx.

Please send me full details of the "Infinite Baffle" Loudspeaker together with a copy of your 20-page technical booklet "The Attainment of an Ideal." I enclose 1d. stamp towards postage.

Name.....

Address.....

W.W. 440. Attach this to your card or letterheading.



# International 'BAND SPREAD RADIO'



The "International" with eight wavebands covers all the worth-while stations in the world and makes it no longer necessary for you to hesitate, or search for the broadcast you want. You select your station—and it is there with the same accuracy as a close-by transmitter. Its ability to bring in short-wave stations is as intriguing as it is effective and the standard of fidelity based on the development of selective inverse feed-back satisfies the most critical listener. Wavelengths: 13.7-14.2, 16.5-17.1, 19.4-20.1, 24.8-25.8, 30.6-31.9, 48-50, 180-560, 850-2,000 metres.

Cabinet finished in sapele mahogany, 10" moving-coil speaker, 6 watts output valve, five valves (including rectifier). Dimensions: 25" x 13½" x 11¼"

Price 16½ gns.

PYE LTD., RADIO WORKS, CAMBRIDGE

# Wireless World

## CLASSIFIED ADVERTISEMENTS

**THE CHARGE** for advertisements in these columns is 12 words or less 3/-, 3d. for every additional word. Each paragraph is charged separately.

**ADVERTISEMENTS**, with remittance, should reach Dorset House, Stamford Street, S.E.1, not later than first post Wednesday, April 10th, for the May issue, or one day earlier at the Branch Offices, 8-10, Corporation Street, Coventry; Guildhall Buildings, Navigation Street, Birmingham, 2; 280, Deansgate, Manchester, 3; 26c, Renfield Street, Glasgow, G.2.

**SERIES DISCOUNTS** are allowed to trade advertisers on orders for consecutive insertions provided a contract is placed in advance, and in the absence of fresh instructions the entire copy is repeated from the previous issue. 3 insertions, 5 per cent.; 6 ins., 10 per cent.; 12 ins., 15 per cent.

Advertisements received too late for one issue, or crowded out, are published in the first following in which there is space. The Proprietors retain the right to refuse or withdraw advertisements at their discretion.

The Proprietors are not responsible for clerical or printers' errors, although every care is taken to avoid mistakes.

**BOX NO. ADVERTISERS** should include the words "Box 000 c/o 'The Wireless World'" which must be paid for. An additional 6d. is charged for registration and cost of forwarding replies.

## ARMSTRONG

### OUR PROMISE FULFILLED

When war was declared we promised not to raise our prices on existing stocks. In November and December we warned you that a slight increase would be inevitable, but that it would be only the barest figure. In January we announced a 5% rise—now, in April, 7 months after the outbreak of war, we are still managing to keep to our pre-war prices plus only the 5%. It is not an easy job because raw material is difficult to get and prices have leapt up, but we are still making the same good quality radio and we still intend the cost to remain as low as possible—for as long as possible. Further increases will have to take place, but again we assure you that we shall keep them down to a minimum. Thus do we keep faith with you and fulfil our promise.

**100%** *The "Wireless World" said:*  
**"Full marks are due to the designer . . ."**  
 of the

**VARIABLE SELECTIVITY MODEL AW125PP**  
**12-V 5-BAND ALL-WAVE R-G CHASSIS**  
 (12—550 continuous, 1,000—2,000 m.)

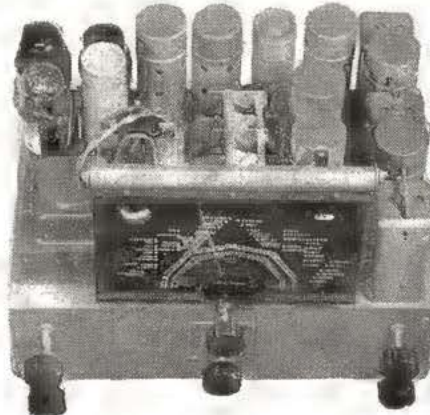

With R.F. Pre-Amplifier, 2 I.F. stages with Variable Selectivity. Manual R.F. gain control and 10 watts R.C. coupled Triode P.P. Output. **17 gns.** Plus 5%

No set could have a finer testimonial than that which appeared in "The Wireless World," January 5th, 1939—Send for official Reprint and full specification.

**MODEL AW38—8-V ALL-WAVE SUPERHET**  
 This radiogram chassis has R.C. Coupled Push-Pull Output capable of handling 6 watts.

This being our Quality Year we have carefully studied the design of our more economically priced **8 gns.** models and it's now possible to obtain excellent quality with economy . . . Plus 5%

**Matched Push-Pull Speaker for above 1 gn.**

**MODEL SS10—10-V SUPERHET-STRAIGHT ALL-WAVE HIGH-FIDELITY R-G CHASSIS**

Incorporating Two Independent Circuits, Superheterodyne and Straight, having R.F. Pre-amplifier and **12 gns.** R.C. Coupled Push-Pull Triode Output capable of handling 8 watts . . . Plus 5%

**7 DAYS' APPROVAL—12 MONTHS' GUARANTEE**

If you haven't seen our Illustrated Art Catalogue describing our full range, drop us a card and we will send one along

**ARMSTRONG MANUFACTURING CO.**  
**WALTERS ROAD, HOLLOWAY, LONDON, N.7**  
 (Adjoining Holloway Road.) Phone: NORTH 3213.

Letters addressed to Box Nos. are simply forwarded to the advertiser. No responsibility is accepted in connection with these advertisements.

**DEPOSIT SYSTEM.** Readers may deal with advertisers in safety through our Deposit System. Purchase money payable to Iliffe & Sons Ltd. should be deposited with "The Wireless World," when both parties are advised of its receipt.

The time allowed for decision is three days, counting from receipt of goods, after which period, if buyer decides not to retain goods, they must be returned to sender. If a sale is effected, buyer instructs us to remit amount to seller, but if not, seller instructs us to return amount to depositor. Carriage is paid by the buyer, but in the event of no sale, and subject to there being no different arrangement between buyer and seller, each pays carriage one way. The seller takes the risk of loss or damage in transit, for which we take no responsibility. For transactions up to £10 a deposit fee of 1/- is charged; over £10 and under £50, 2/6; over £50 and under £75, 5/-; over £75 and under £100, 7/6; over £100 one-half per cent. All correspondence must be sent to Dorset House, Stamford Street, London, S.E.1.

Cheques and Postal Orders sent in payment for deposits or advertisements should be made payable to Iliffe & Sons Ltd., and crossed. Notes cannot be traced if lost in transit. They must therefore be regarded as being despatched at sender's risk. Alternatively, they may be sent per registered post.

## NEW RECEIVERS AND AMPLIFIERS

\* **"CHALLENGER RADIO CORPORATION,"** the best firm for reliable and fully guaranteed ultra-short-wave radio, have on view in London some of the finest receivers ever made; for instance, a five-valve TRF Midget (2 bands) at 75/-; a mains-battery transportable (operating without alteration on A.C., D.C., or batteries), at £8; an 8-valve radiogram chassis with valves and speaker, 4 wave-bands, at £8/8; a 6-valve tuning unit with five wave-bands, including 4½-10 metres, at £8/18/6; tuning unit with output stage and speaker at £11; a 13-valve receiver with five wave-bands, including 5-10 metres, variable selectivity inter-station noise silencer, chassis, valves and auditorium speaker complete, £16/16; an 18-valve twin chassis including such refinements as variable selectivity, contrast expansion, C.W. beat oscillator, variable sensitivity, inter-station noise silencer, with valves and auditorium speaker, £28/17/6; any American valve for 1925-1940 receivers for 6/- each (only firsts such as Raytheon, National Union, &c., supplied). Why not call and handle these receivers at your leisure? There is no obligation to purchase. Alternatively, fully illustrated catalogues will be forwarded on receipt of 1½d. stamp.

**CHALLENGER RADIO CORPORATION,** 31, Craven Terrace, London, W.2. Paddington 6492. Nearest point Marble Arch, down Bayswater Rd., turn 5th right. [8787]

**BANKRUPT Bargains.**—Brand new 1939 models, makers' sealed cartons, with guarantees, at less 33½% below listed prices; also Midgets, portables, car radio; send 1½d. stamp for lists.—Radio Bargains, Dept. W.W., 261-3, Lichfield Rd., Aston, Birmingham. [8921]

**THE** famous Hallicrafter SX23, released by the makers only in July, 1939, can still be supplied by Webb's Radio at pre-war prices. We fortunately had good supplies delivered in August. No price increase on present stock of this model only; £33/10; H.P. terms available. Write for descriptive folder "W."—Webb's Radio, 14, Soho Street, London, W.1. Phone: Gerrard 2089. [8766]

## COMMUNICATION RECEIVERS

**NEW** Howard 440, £31/12/6; Howard 450A, £35; Howard 430, £11/10; National One-Ten Power Pack, £5/5; National Oscilloscope, £6/6; Miller Pre-selector, £8/8; Hallicrafter HT7 frequency checker, £10; improved 1940 Hamrad, £30.—A.C.S. Radio, 46, Widmore Rd., Bromley. [8900]

**EDDYSTONE E.C.R.**, with speaker, cost £45, dem. soiled, £33/10; Sargent Streamliner 39, with speaker, as new, £9/15.—A.C.S., 46, Widmore Rd., Bromley. [8901]

## USED SETS FOR SALE

### ANSON

**A**NSON 500-gn. Autoradiogram, fitted with 24-valve American Challenger all-wave chassis, 4½-2,000 metres continuous, 3 Rola speakers, 30 watts output, marvellous tone, record changer, plays 30 records, turns them over, plays both sides, beautiful secretaire cabinet in solid Spanish mahogany, record storage for 300 records on automatic selection system; £60, an outstanding bargain; wants seeing to be appreciated.—Box 1938, c/o *The Wireless World*. [8930]

### CHALLENGER

**1938** Sky Challenger, xtal gate, new condition; £15.—Bonelle, 66, Edward St., West Bromwich. [8897]

### HALLICRAFTER

**H**ALLICRAFTER S.X.23 with Speaker, 220 volts, only two weeks old; accept £30.—Box 1935, c/o *The Wireless World*. [8927]

### McMURDO

**M**CMURDO Silver Olympic Autoradiogram, 72-gn. model, 15 valves, 4½-2,000 metres, 15in. speaker, as new; £40.—Box 1937, c/o *The Wireless World*. [8929]

### MARCONI

**1940** Marconi 44-gn. All-Wave Radio and Television Console, as new; £18/18.—Box 1939, c/o *The Wireless World*. [8931]

### MURPHY

**M**URPHY Console, Model A26C, perfect; £8/10.—A.C.S., 46, Widmore Rd., Bromley. [8899]

**M**URPHY Console Television Receiver, Model A56V, picture size 7in.×6in., new in August last, used for one week only, under makers' guarantee; must sell owing joining H.M. Forces; cost £30, accept £15 quick sale.—Box 1952, c/o *The Wireless World*. [8935]

### PHILCO

**1940** Special Philco (American) Tropic Short Wave 11-valve Table Model, three short wave and medium bands, 100-250 volts 10 watts output, really amazing S.W. performance, laboratory built model, cost 38 gns.; accept £14, plus carriage.—Box 1934, c/o *The Wireless World*. [8926]

### SCOTT

**SCOTT** 27-valve Imperial, Auto-radiogram, in Warwick Grande cabinet, cost £275, perfect; £85.—A.C.S., 46, Widmore Rd., Bromley. [8898]

**SCOTT** 32-valve Philharmonic Chassis, latest model, the world's finest radio, cost £200; accept £87/10.—Box 1936, c/o *The Wireless World*. [8928]

# Flights of Fancy



## Will become reality!

... when these armatures have their reproducing points and are fitted into experimental Voigt moving coil pickups.

The points will be much smaller than the ordinary needles shown for comparison.

The output of the Pickup will be low in voltage but high in quality, and the price about £6.

Advance information will be ready shortly. If interested, please write NOW.

## VOIGT PATENTS LTD.

THE COURTS · SILVERDALE · S.E.26

Telephone: SYDenham 6656

Regd. Office: 22, Castle Street, E.C.1.

**TRANSFORMERS & CHOKES**  
by  
**PARTRIDGE**  
a guarantee in itself

It was to be expected that, as the leading manufacturers of high grade transformers, we should be asked to handle certain work relating to war requirements.

But it has not been forgotten that the trade and the private user provided the demand that made possible the popularity of Partridge Transformers.

Our policy is, therefore, to study the needs of old customers; and to endeavour to maintain pre-war standards of quality and service. Although Government work must be given priority, the Partridge Organization is still primarily for you



King's Bldgs., Dean Stanley St., London, S.W.1.

Phone: VICTORIA 5035

### USED SETS FOR SALE Wanted

"W.W." Straight Six Chassis, or Micron coils; cheap.—54, Scalpcliffe Rd., Burton-on-Trent. [8893]

WANTED, second-hand "Sky Champion" Receiver (1933-39).—Iszby, Lynmouth, Spring Park Ave., Croydon. [8907]

WANTED, W.W. Monodial Super 1933 Tuner and Amplifier; specified parts.—Thorne, 42, Totley Brook Rd., Sheffield. [8880]

### PUBLIC ADDRESS

VORTEXION P.A. Equipment, IMITATED, but unequalled.

WE Invite You to a Demonstration.

A.C.-D.C. Dance Band Amplifier, 10 watts output. complete in case, with moving coil microphone, speaker and cables weight 22lb.; 12 gns.

A.C.-20 15-20-watt Amplifier, 58-18,000 cycles, independent mike and gram, inputs and controls, 0.037 volts required to full load, output for 4, 7.5, and 15 ohms speakers, or to specification, inaudible hum level, ready for use; 8½ gns. complete.

C.P. 20 12-volt Battery and A.C. Mains Model, as used by R.A.F., output as above; 12 gns.

A.C.-20, in portable case, with Collard motor, Piezo pick-up, etc., £14; C.P.20 ditto, £17/17.

50-WATT Output 6L6s, under 60-watt conditions, with negative feed back, separate rectifiers for anode screen and bias, with better than 4% regulation level response, 20-25,000 cycles, excellent driver, driver transformer, and output transformer matching 2-30 ohms impedance electronic mixing for mike and pick-up, with tone control, complete with valve and plugs. £17/10.

COMPLETE in Case, with turntable, B.T.H., Piezo pick-up and shielded microphone transformer; £22/10.

80-WATT Model, with negative feed back; £25, complete.

120-WATT Model, with negative feed back; £40, complete.

250-VOLT 250 m.a. Full Wave Speaker, field supply unit; 25/-, with valve.

6- or 12-volt Car Battery Charger, 30/-; complete in gauze case, 35/-.

ALL P.A. Accessories in Stock; trade supplied.

SEE Our Display Advertisement on Page 231.

VORTEXION, Ltd., 182, The Broadway, Wimbledon S.W.19. Phone: Lib. 2814. [8241]

"PARTRIDGE P.A. Manual," standard handbook on electro-acoustics, amplifiers, and audio circuits; price 2/6. (free to trade)

"PARTRIDGE Amplifier Circuits," describes many modern, constructional amplifiers, 2w. to 45w. output, battery, A.C.-D.C., etc.; price 2/- (no free copies).

PARTRIDGE, N., B.Sc., A.M.I.E.E., King's Buildings, Dean Stanley St., London, S.W.1. [0630]

### NEW MAINS EQUIPMENT

VORTEXION Mains Transformers, chokes, etc., are supplied to G.P.O., B.B.C., L.P.T.B.; why not you?

VORTEXION, Ltd., 182, The Broadway, Wimbledon, London, S.W.19. Telephone: Liberty 2814. [8242]

ALL-POWER TRANSFORMERS, Ltd.—Transformers and chokes to specification, rewinds; write for quotation.—8a, Gladstone Rd., Wimbledon, S.W.19. Liberty 3305. [8913]

### SHORT-WAVE EQUIPMENT

GENI for Short Wave Equipment; largest stocks in the country; communication receivers; National agents; American and British Valves, etc. See advertisement on page 9.—44, Holloway Head, Birmingham. [0531]

"H.A.C." One-valve Short-wave Receiver, famous for over 5 years, now available in kit form; complete kit of precision components, accessories, full instructions, 12/6, post 6d., no soldering necessary; descriptive folder free on request.—A. L. Bacchus, 109, Hartington Rd., S.W.8. [8881]

### NEW LOUD-SPEAKERS

BRAND New Speakers.  
SAVE Pounds. 1½d. stamp for list of British and American P.A. speakers. Example: P.A. speaker with transformer, weight 21lb., incorporating curved cone; 52/-.

CHALLENGER RADIO CORPORATION, 31, Craven Terrace, London, W.2. Paddington 6492. [8789]

BAKERS Brand New Surplus Speaker Bargains.

EVERY Music Lover Interested in Realistic Reproduction Should Write for Free Descriptive Leaflet Now.

(This advt. continued on page 12.)

# L-R-S EASY TERMS

The modern method of acquiring the most modern radio at a modest monthly outlay.

**ARMSTRONG Model AW125PP**  
12-Valve 5-Band ALL-WAVE  
R.G. CHASSIS (12-2000 metres)

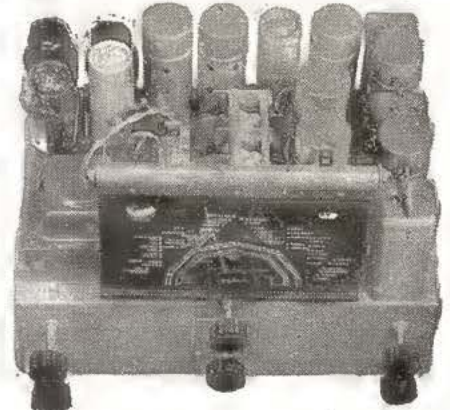

For full description, see Armstrong advert. p. 10.

Cash or C.O.D. **£18. 15. 0**  
Or £3.16.0 with order and 8 monthly payments of £2.0.0.

MODEL SS10—10-v Superhet-Straight  
Cash or C.O.D. **£13. 4. 0**  
Or 45/- with order and 10 monthly payments of 23/-

MODEL AW38—8-v All-Wave Superhet  
Cash or C.O.D. **£8. 16. 6**  
Or £2.5.6 with order and 7 monthly payments of £1.0.0.

WRITE for full specification, Price Lists and Term for complete Armstrong range.

In addition we shall be glad to quote for all other high-grade equipment, such as Sounds Sales Amplifiers, Voigt Speakers, Haynes Radio, Avometers, and PORTABLE A.R.P. RECEIVERS.

### ● JOHN McCLURE ● FEEDER and TUNING UNITS

on convenient terms—  
These excellent Feeder Units so favourably reviewed and recommended by "The Wireless World" last month are now available from us on our usual terms. For example:

TYPES ACF4 & UF4. Cash or C.O.D. **£8. 18. 6**  
Or £1.8.6 with order and 8 monthly payments of £1.0.0.

Full details of other Units on request.

DRY SHAVERS on 14 DAYS' APPROVAL  
against cash or on first instalment of 10/-. Should the shaver be returned, 7/6 will be refunded.

VICEROY Non-electric **£2. 10. 0**  
Or 10/- with order and 6 monthly payments of 7/2.

SHAVEMASTER Electric **£4. 4. 0**  
Or 10/- with order and 8 monthly payments of 10/-.

### ELECTRICAL APPLIANCES

Fires, Vacuum Cleaners, Clocks, Irons, Fans are all available on our convenient terms.

Write TO-DAY for illustrated details.

Evacuation address: Est. 1925

**THE LONDON RADIO SUPPLY COMPANY**  
"Winden," Ardingly Road, Balcombe, Sussex

# ELECTRADIX

OUR NEW ILLUSTRATED APPARATUS AND SIGNAL LISTS ARE NOW READY! WAR EQUIPMENT FOR SERVICE WORK



**SERVICE TYPE SIGNALERS' DOUBLE HEADPHONES.** with flat leather headbands for steel helmet wear, 120 ohms, by S.T. Co., 3/6. 4ft. cords, 6d. Single 60 ohm phones with cord, D.H.I., 1/6. **FIELD TELEPHONE EXCHANGES.** 3-line and 20-line portable. Twin and Single Cable. **HEADPHONE CORDS.** Service, 6ft., fitted 2-pin plugs and 2-hole socket, 2/-; Radio Phone Cords, 2/6. **CRYSTAL SETS.** Boudoir, 6/6. E.M. Table, 7/6. **LEARNERS' MORSE PRACTICE SETS.** Visual Type No. 2A with Key and Lamp on base, No. 3A Duplex with Key and Buzzer and Lamp for sound and visual, on base, 7/-. **Siemens Service Set, 17/6. MORSE KEYS.** Keys for training code users. First class at low prices. A good small key on moulded base is the T.X. brass, solid pivot bar, adjustable tension, etc. B.2. 7/6; Superior Type P.F., fully adjustable, nickel finish, 9/6; High Grade Type IV, plated fittings, polished wood base, a fine key, 10/6. W.D. Special Key on 3-switch box for buzzer and 2 lamps, C.A.V., 6/6.

**BUZZERS,** small type, with cover, 1/6. **Power Buzzers,** with screw contact and adjustable spring armature, 2/6.

**SIGNAL LAMPS.** Adids and Lucas Special Light Practice Sets to service requirements to order.

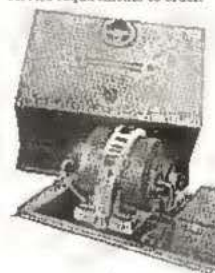

**RADIO ROTARY CONVERTERS.** For A.C. Receivers on D.C. mains to 230 v. A.C. output. In all-enclosed cabinet, with filter. All sizes in stock from 15 watts upwards, 30, 50, 100, 200, 400, and 800 watts; 1 k.W., 11 k.W., etc. Also battery operated 50-watt size in 12 volts and 50 volts input. **230/230 VOLTS MAINS CONVERSION UNITS.** For operating D.C. from A.C. mains, creamed and filtered, 120 watts output, £2 10s.

**D.C. ROTARY CHARGERS.** 3 h.p. 220 volt D.C. motor, 6 volt 250 amp. dynamo, £16. 200 volt motor, 25 volt 8 amp. dynamo, £4. Motor 8 amp. dynamo, £2.

220 volt, 8 volt 50 amp. dynamo, £8 10s., and others up to 6 k.W.

**A.C. ROTARY CHARGERS.** 3-phase motor, 200 volt to D.C. dynamo 8 volts 15 amps., £4 17s. 6d. R.C.A. 3-ph. motor, 220 volts, coupled to D.C. dynamo, 500 volts 200 m.A., £5 10s. Single-phase to D.C., Higgins 230 volt A.C. motor, coupled to D.C. dynamo, 8 volts 16 amps., £5 10s. B.T.H., ditto, 1 h.p. motor with starter on bed with 15 volt 30 amp. dynamo, £7 10s.

**300-CELL A.C. CRYPTO MOTOR-GEN. SET.** For 220 volt A.C. mains, for radio cell circuits and ten 12 volt 10 amp. car batteries, D.C. output, £32.

**CRYPTO CONSTANT POTENTIAL SET.** A.C. motor, Rectifier output 8/16 volts 50 amps. and 100 volts 1 amp., with switchboard for dealing with 250 cells per week. Almost new, cost £48; sale, £23.

**A.R.P. PETROL-ELECTRIC GENERATING SETS FOR LIGHTING AND CHARGING FOR £16 ONLY.** A 500-watt, single-cyl., 2-stroke, water-cooled, self-igniting Stuart Turner engine; max. ign. coupled to 50/70 volts 10 amps. shunt dynamo, 1,000 r.p.m., £16. No increase in price, these are £40 sets ready for immediate delivery.

**FOR £12.** A 150-watt engine and dynamo on similar lines, but coupled to 25/30 volts 8 amps. dynamo.

**A.C. MAINS CHARGERS. LESDIX TUNGAR CHARGERS.** Two models of these famous sets. One for 70 volts 6 amps. with meter and controls, etc., will handle 100 cells a day, £2 17s. 6d. Another fine Tungar for two 5 amp. circuits with meters and variable volt controls, 70 volts 10 amps., for 200 cells; bargain, £12 15s.

**A.C. D.C. DAVENSET.** Type G.C. House, Garage Wall Type Charger, 3 circuits, output D.C. 25 volts 6 amps. Trans. tapped for 15 volt, 30 volt, 25 volt. Two independent circuits, max. cell capacity 40 radio cells, £8 5s.

**PHILIPS Model 1057,** with valve for 24 volts 10 amps. Steel case, £7 10s.

**DAVENSET A.S.C.A.** 4-circuit charger for up to 80 cells. List Price £32. Four sets of Auto-charge regulators and indications on panel with switch volt control. Four circuits of 1 amp., 1 amp., 2 amps., and 2 amps. or three of 1 amp., 2 amps. and 2 amps., or one of 50 volts 6 amps. Fine steel clad ret., complete in details that will quickly earn its cost; £14 10s.

**H.T. BATTERY SUPERSEDERS.** 85 v. at 6 m.A. for H.T. from your 2-volt battery, no H.T. batteries, 7in. x 4 1/2in. x 3in. Bakelite finish. Vibrator and Metal Rectifier, by S. G. Brown. Sale, 37/6. Full guarantee. Type 8, for larger sets. Can be supplied for either 2-volt, 4-volt or 6-volt battery. Model 10, output D.C. 120 volt 10 m.A., 2 taps, 65/-; Model 20, output D.C. 135 volt 20 m.A., 3 taps, 70/-; **VIBRATORS,** 6/12 volt car type, 4 amp., 10/-; T.V.T. Sets, 6 volts to A.C., 25/-.

**5- EMERGENCY PARCELS** of useful stand-by electrical and radio repair material and apparatus, 10 lbs. for 5/-. Post Free.



Send for 1940 Bargain List "W."  
**ELECTRADIX RADIOS**  
 218, UPPER THAMES STREET, LONDON, E.C.A.  
 Telephone: Central 4611

## NEW LOUD-SPEAKERS

(This advert. continued from page 11.)

**BAKERS** New Corner Horn Speakers, electro and permanent magnet models, complete with beautifully finished polished walnut corner horn cabinets, frequency range 30-12,000 cycles, amazingly realistic reproduction, brand new at half usual prices, as follows:—

**£12** Only; usual price £24.—Brand new A.C. corner horn speaker with 40 watt rectifier.

**£11** Only; usual price £22.—Brand new D.C. corner horn speaker, field resistance as required.

**£8** Only; usual price £16.—Brand new permanent magnet corner horn speaker, exceptional value.

**BAKERS** New Super Quality Triple Cone Speakers, electro and permanent magnet models, ideal for use with quality amplifiers, brand new at half usual prices, as follows:—

**£5/10**; usual price £12.—Brand new A.C. super quality triple cone speaker with 40 watt rectifier.

**£3/15**; usual price £9.—Brand new D.C. super quality triple cone speaker, field resistance as required.

**£2/5**; usual price £5.—Brand new permanent magnet super quality triple cone speaker, exceptional bargain.

**BAKERS** New Super Quality Infinite Baffle Speakers, permanent magnet models, wide frequency range and exceptional transient response, brand new at half usual prices, as follows:—

**£4/15**; usual price £10.—Brand new permanent magnet infinite baffle speaker complete with beautifully finished cabinet in polished walnut.

**£3/15**; usual price £9.—Brand new permanent magnet infinite baffle speaker complete with cabinet in white wood stained.

**SECURE** One of These Super Quality Speaker Bargains Now.

**BAKERS SELHURST RADIO,** The Pioneer Manufacturers, 75, Sussex Rd., South Croydon. [8917

## SECOND-HAND LOUD-SPEAKERS

Wanted

**DUODE 33,** 1,250 ohms, good condition essential.—Box 1916, c/o The Wireless World. [8915

## TRIPLE CONE CONVERSIONS

**BAKERS** Triple Cone Conversions Will Immensely Improve Reproduction of Your Present Speaker. No matter what type or make you possess you can considerably improve frequency response and quality of reproduction by having a triple cone fitted. The following is typical of many unsolicited testimonials:—  
 "Enstone," Lincoln Grove, Newcastle-U-Lyme, Staffs. My speaker arrived safely on Saturday and has now been put in commission. The results are truly amazing, the bass register is reproduced faithfully whilst the upper frequency response is brilliant. For a few shillings you have converted a speaker scheduled for the scrap heap into one worth pounds. I am indeed very satisfied.—W. E. Darby (Grad. I.E.E.).  
**FREE** Descriptive Leaflet from Bakers Selhurst Radio, 75, Sussex Rd., South Croydon. [8918

## CABINETS

**A CABINET** for Every Radio Purpose.  
**SURPLUS** Cabinets from Noted Makers Under Cost of Manufacture.  
**UNDRILLED** Table, console and loudspeaker cabinets; from 4/6.  
**RADIOGRAM** Cabinets; from 30/-.  
**INSPECTION** Invited.

**H. L. SMITH** and Co., Ltd., 289, Edgware Rd., W.2 Tel: Pad. 5891. [0485

**CHALLENGER RADIO CORPORATION** for the finest obtainable cabinets, table, Console and radiogram; also record-changers at £5/11; send 1/6d. stamp for list "Illustrated."—Challenger Radio Corporation, 31, Craven Terrace, London, W.2, Paddington 6492. [8790

## DYNAMOS, MOTORS, ETC.

**ALL** Types of Rotary Converters, electric motors, battery chargers, petrol-electric generator sets, etc., in stock, new and second-hand.  
**A.C. D.C. Conversion Units** for Operating D.C. Receivers from A.C. Mains, 100 watts output, £2/10; 150 watts output, £3/10.  
**WARD,** 46, Farringdon St., London, E.C.4. Tel: Holborn 9703. [0518

Wanted

**PHILIPS** Tubular Vibrator Converter, price and condition.—King, 66, Harcourt Ave., London, E.12. [8871

## RECORDING EQUIPMENT

**PRESTO** Professional Disc Recorder, with amplifier, speaker and play-back, portable, cost £120. £47/10; Permanent cutting-head and tracker, £3/15. Crystal mike on table stand, £4/10.—A.C.S., 46, Widmore Rd., Bromley. [8903

# TAYLOR

## PRECISION INSTRUMENTS

Our range includes:—

### UNIVERSAL METERS

70 Ranges of A.C. and D.C. Volts and Amps., Ohms, Capacity, Inductance and Decibels. Strongly constructed, well-balanced Moving Coil Meter, Hand-calibrated for extreme accuracy.

Model 50A, 2,000 P.P.V., AC/DC	11 Gns.
" 80B, 5,000 O.P.V., DC	13 Gns.
" 80C, 20,000 O.P.V., DC	15 Gns.

82 Ranges of A.C. and D.C. Volts, Amps., and Ohms. All-metal construction incorporating Hand-calibrated Moving Coil Meter.

Model 90, 1,000 O.P.V., AC/DC	£8 15 0
17 Ranges DC	
Model 95, 1,000 O.P.V.	£8 10 0

### VALVE TESTERS

Taylor Model 45 Valve Tester accurately checks all English, Continental and American Valves, from 0.25 millamps per volt and up to 24 MA/volt. Over 1,000 readings: 17 Valve Holders £13 2 6  
 Portable Model £13 18 0  
 Bench Model 13 Gns.  
 Model 40 checks over 800 English and American Valves for slope, filament continuity, cathode, leakage and shorts.  
 Standard Model £9 9 0  
 Portable Model £9 18 6

### SIGNAL GENERATORS

Taylor Precision-built, mains-operated Signal Generator, covers 6.5 to 3,000 metres, 100 kc. to 48 mc. in 6 bands, directly calibrated. Almost constant output; low harmonic content. MODELS FOR A.C., A.C./D.C. or BATTERY OPERATION 11 Gns.

### OSCILLOSCOPES

These instruments use a 3-in. hard type Cathode Ray Tube, have separate built-in amplifiers for both the horizontal and vertical anodes, as well as a linear time base.

Model 30	18 Gns.
Model 35 (with frequency modulated oscillator)	22 Gns.

TAYLOR INSTRUMENTS ARE BRITISH MADE

Full particulars of any instrument sent on receipt of your name and address pinned to this advertisement.

**TAYLOR ELECTRICAL INSTRUMENTS, LTD.**  
 419-422, Montrose Avenue,  
 TRADING ESTATE, SLOUGH, BUCKS.  
 Phone: Slough 20061.

## DEAF?

### VALVE INSTRUMENTS BY RADIO-AID

Deaf people who read Dr. Littler's interesting and informative article in last month's "Wireless World" but who do not possess the technical skill or facilities for making up their own instruments may be interested to know that Radio-Aid Ltd., specialists for nearly ten years in valve instruments, have now produced a new range of instruments similar in design to those described in this paper and at a price compatible with War Time Conditions.

Full Literature on request.

### CONSULTING ROOMS:—

## 88, WIGMORE STREET, LONDON, W.1.

WELbeck 7176.

Greenwood

### BOOKS on WIRELESS

Write for complete list to  
**ILIFFE & SONS LTD.**  
 Dorset House, Stamford St., London, S.E.1 w.w.

VALVES

ALL Types of American Tubes in Stock of Impex and Arcurus makes at competitive prices. WE Can Also Supply a Full Range of Guaranteed Replacement Valves for Any British non-ringing American or Continental type at an appreciably lower price. SEND for Lists of These, and also electrolytic condensers, line cords, resistances, etc. CHAS. F. WARD, 46, Farringdon St., London, E.C.4. Tel.: Holborn 9703. [0452] METROPOLITAN RADIO SERVICE.—American valves, in all types, trade supplied.—1021 Finchley Rd., N.W.11. Speedwell 3000. [0436]

ELECTRICAL EQUIPMENT

A.C. and D.C. Surplus Electric Equipment, chargers, 1 and 3 ph. motors, dynamos, converters, pulleys; offer to clear, space wanted.—Easco, 18, Brixton Rd., S.W.9. [0645]

TEST EQUIPMENT

UNIVERSAL Avomitor, in pigskin leather case, with Avodaptor, for sale, in brand new condition; owing to death of owner accept £12, or nearest offer.—Box 1870, c/o The Wireless World. [8895] NEW Triplett 666H Pocket Tester, £6; Triplett 1200B volt-ohm-milliammeter, £10/10; Triplett milliammeters, 0-10, 0-25, 0-50, 0-100, 0-250, 27/6; 0-1 m.a., 32/6.—A.C.S. Radio, 46, Widmore Rd., Bromley. [8902] OUR A.C.-D.C. Multimeter Kits Incorporate New 2 1/2 in. Scale Ferranti Meters with ohms-watt-decibel scales, Manganin shunts (1%), latest Westinghouse rectifiers, and silver-contact selector switches, 45 ranges; from £3/10.

KITS and Components for Probe Valve Voltmeter (mains or battery), bridges, circuit analysers, etc. STAMP for Lists of Above, and Ferranti meters, available.—L. A. MacLachlan and Co., Strathvire. [8924]

Wanted

WANTED, Ferranti milliammeters, 0 to 1.—Leach, 92a, Kensington High St., W.8. [8889] Cossor Oscilloscope, double or single.—Particulars to Joyce, 31, Ramsgate Rd., Margate. [8914]

METERS, ETC.

FERRANTI Meters.—Quantity of following: 2in. Thermal, 0-1A, 17/- each; moving coil, 0-300V, 1,000 o.p.v., ditto 20-0-20A, ditto 0-40v, ditto 2 1/2 in. 0.75A; ditto cell testers, 3-0-3 and 30-0-30v, to W/T Board spec., new, 12/6 each.—Green, 34, Chester Rd., Hulme, Manchester. [8911]

COMPONENTS

SECOND-HAND. CLEARANCE, SURPLUS. LONDON CENTRAL RADIO STORES, 23, Lisle St., W.C.2. Gerard 2969.

MULTI Contact Selector Switcher, 12/6; Cossor battery, 210 S.P.T., 4/6 each; Cossor battery, H.F. or det., 2/6 each; Philips step down transformers, input 200-240 volts, output 6 volt 3 amps., 2/9 each; open circuit jack and plug, 1/6 complete; ex-G.P.O. multi contact relays, used in automatic exchanges, new condition, suitable for automatic tuning, complete with contacts, 2/3, post free; also superior models, 3/6 and 4/6 each. LONDON CENTRAL RADIO STORES, 23, Lisle St., W.C.2. Gerard 2969. [8920]

VAUXHALL.—Rola G12 P.M. speakers, 69/6; 812 energised, 55/-; all brand new with input transformer. VAUXHALL.—Rola P.M. speakers, 8in., 14/9; 10in., 18/6; Rola energised 1,500 ohm speakers, 8in., 12/6; 10in., 15/3

VAUXHALL.—Collaro A.C. gramophone motors, turntable, 30/-; Collaro A.C. motors with magnetic pickup, complete, 52/6; Collaro A.C. motors with crystal pickup, complete, 65/-

VAUXHALL.—Skeleton metal rectifiers, HT10, 11/-; HT9, 9/-; valve holders, 7-pin, 6d.; 5-pin, 5d.; volume controls, 2/-; with switch, 3/-

VAUXHALL.—Electrolytic condensers, 50 mfd. 50v. 1/9; 50 mfd. 10v. 1/6; 1 mfd. 500v. 7d.; 0.1 mfd. 350v. 3d.; all tubular types

VAUXHALL.—T.C.C. cardboard containers, 8 mfd. 500v., 2/-; 8 plus 8 mfd., 3/3; 6 plus 4 mfd. 350v., 1/9; high class electric dry shavers for A.C./D.C. mains, 27/6

VAUXHALL.—Flat sheet hard copper, 12x12in., 3/9; 12x24in., 6/6; 24x24in., 9/3; guaranteed electric lamps, 1,000 hours service, all voltages, 1/-, post 2/6d.

VAUXHALL.—Bar type condensers, straight 0.0005 mfd., 2-gang, 6/6; 3-gang, 8/6; full vision drives, 6/-; Resinoid condensers, 4 mfd. 450v., terminals, 1/9

VAUXHALL.—Modern pickups, volume control, 11/- and 18/9; all above goods brand new and unused. VAUXHALL UTILITIES, 163a, Strand, London, W.C.2. Write for free list. [8916]

5/- Only.—Bargain parcel comprising speaker cabinet, drilled steel chassis, condensers, resistances, and many other useful components, worth 35/-, limited number; postage 1/-.—Bakers, Selhurst Road, 75, Sussex Rd., South Croydon. [8919]

GALPINS ELECTRICAL STORES 75, LEE HIGH ROAD, LEWISHAM, LONDON, S.E.13 Telephone: LEE GREEN 5240

Terms: Cash with Order ALL GOODS SENT ON THREE DAYS' APPROVAL AGAINST CASH TRUVOX PUBLIC ADDRESS HORN SPEAKER UNITS, 15 ohm Speech Coil, 6 volt field, 15/- each, post 1/6. DYNAMOS, for charging or lighting, etc., all shunt wound and fully guaranteed. 100-volt 10 amp., 4-pole, 1,500 r.p.m., 90/-; 50/75-volt 15 amp., 1,750 r.p.m., 4-pole 90/-; 30-volt 10 amp., ball bearings, 1,500 r.p.m., 4-pole, 70/-; 25-volt 8 amp., 1,750 r.p.m., 2-pole, ball-bearing, 37/6; 50/75-volt, 25 amp., 4-pole, 1,500 r.p.m., 110/-

ELECTRIC LIGHT CHECK METERS, for sub-lettings, garages, etc. 200/250 volts, 50 cy. 1-ph., supply 5, 10 or 20 amps., 6/- each, post 1/-

SAVAGE MAINS TRANSFORMERS, input 200/250 volts, output 50 volts at 6/8 amps., useful for arc lamps, etc., 15/- each, post 1/-

EVERSHED EX-R.A.F. HAND-DRIVEN GENERATOR, in new condition, 800 volts 30 m.a. and 6 volts 2 1/2 amps. D.C. Useful as megger genies and all test work, 20/- each, post 1/6

EX-G.P.O. GLASS TOP RELAYS, Type B. Useful as Keying Relays, 5/- each, post 6d. T.C.C. 2,000 MF. ELECTROLYTIC CONDENSERS, 50-volt working (brand new), 5/- each, post 6d. STANDARD TELEPHONE BELL WIRE, all brand new. 150-yd. coils, twin 22 gauge, 4/-, post 9d.; 250-yd. coils, single 18 gauge, 4/-, post 1/-; 300-yd. coils, single 22 gauge, 3/-, post 6d.

MOVING COIL MOVEMENTS, complete in case with pointer, very low m/a., full deflections, 2 1/2 in. dia., 5/-, post 6d.; 4 in. dia., 6/-, post 9d.; and 6 in. scale, 7/- each, post 9d.

PUSH-BACK WIRE, 22 gauge, 220-yd. coils, as new, price per coil, 8/6, post free. EVERSHED RECORDING VOLTMETERS, 80/120 volts D.C., in good condition, 70/-, C/F; ditto, 20 amp. Recording Meter, 70/-, C/F.

PORTABLE LIGHTING ENGINES, 2 1/2 twin Douglas special, air cooling, complete with all fittings, including petrol tanks, etc., fully protected, condition as new, £10, C/F. SPARK COILS, ex-Naval, 2in. spark, complete for 12-volt working, 25/- each, post 1/6.

SILVERTOWN HORIZONTAL GALVANOMETERS, jewelled movements, 5/- each, post 6d. KEITH BLACKMAN MOTOR-DRIVEN PUMPS, for water, 1 h.p., 110-volt D.C., ball-bearing, shunt-wound, 1,200 r.p.m., gear type gunmetal pump, 3in. inlet and outlet, total head 30 feet, 300 gallons per hour, 45/- each, C/F; 220-volt ditto, 55/- each, C/F.

SMALL D.C. MOTORS, 100 volts, shunt-wound, laminated field, 2-pole, 1 h.p., 12/6 each, post 1/-

ANOTHER, 50/100-volt D.C., shunt-wound, ball-bearing, totally enclosed, 7/6 each, post 1/-

EVERETT EDGEMBLE ELECTROSTATIC VOLT-METER, 8in. dial, 0 to 6,000 volts, in good condition, 55/-, post 2/-

MORSE TRANSMITTERS, perforator types, motor driven, complete with motor, 100/200 volts D.C., in very good condition, 70/- each

STANDARD TELEPHONE CONDENSERS, 1 mf. 400-volt wkg., 4d. each, or 4 for 1/-; 2 mf. 400-v. wkg., 6d. each. Muirhead, 1 mf. 4,000-volt test, 2/- each. Philips, 1 mf. 8,000-volt test, 5/- each. T.C.C. 2 mf. 1,000-volt test, 1/- each. T.C.C. 2,000 mf. 12-volt wkg., 2/- each

X-RAY TRANSFORMERS. All in good condition, fully guaranteed 120 volts, 50 cy. 1-ph. input, 64,000 volts 2 kVA. output, with winding for Coolidge Tube, £11 10s. Another, same input, 80,000 volts 3 kVA. output, £14 10s. Another, 200/240-volt input, 4,000 volts 12 m/a. output, £6. All Carriage Forward.

WESTON (501) AND E. TURNER (909) 2in. DIAL MOVING-COIL MILLIAMMETERS, as new. 0 to 5 m/a., 17/6; 0 to 25 m/a., 16/6; 0 to 50 m/a., 15/-; 0 to 250 m/a., 15/- each

MULTI-CONTACT RELAYS, EX-G.P.O., as used in automatic exchange, condition as new, small size, suitable for automatic tuning for press-button control, heavy platinum contacts, 2/6, post 3d.; 2 for 4/- post 6d.; 3 for 6/-, post 6d.

VOLTAGE CHANGING TRANSFORMERS (Auto. wound), 12 months guarantee, 100/110 to 200/240 volts or vice versa; 250 watts, 21/-; 500 watts, 26/-; 750 watts, 32/6; 1,000 watts, 37/6; 1,500 watts, 50/-; 2,000 watts, 62/6

HIGH VOLTAGE TRANSFORMERS for Television, Neon, etc., 200/240 v. 50 cy. 1-ph. primary; 5,000 and 7,000 volts secondary, enclosed in petroleum jelly. Size: 5 1/2 in. x 4 1/2 in. x 4 1/2 in., 7/6 each, post 1/-

Ditto, skeleton type, 5/6, post 9d. All brand new. PAUL & GAMBRELL WHETSTONE 1 to 10,000 OHM RESISTANCE BOXES, in good condition, £5 each; ditto, with Mirror Deflecting Galvanometer, £6, Carriage forward.

COMPONENTS—SECOND-HAND

CLEARANCE, SURPLUS, ETC.

PREMIER RADIO.

PLEASE See Our Displayed Advertisement on page 5. [0488]

SOUTHERN RADIO'S Bargains.

ALL Guaranteed; postage extra.

5/- Parcel of Useful Components, comprising condensers, resistances, volume controls, wire, circuits, etc., value 25/-; 5/- per parcel.

15/-—Service man's component kit; electrolytic condensers, volume controls, resistances, tubular mica, paper condensers, valve holders, etc. 120 articles, contained in strong carrying case, 9in. x 7in. x 7in.; 15/- the kit.

5/-—100 wire end resistances, assorted capacities, 1/2 and 1 watt; 5/- per 100.

ORMOND Loud Speaker Units, 2/6; Westectors, type W2, 2/6; Crystal Detectors, 2/-; Crystals, 6d.; Marconi V24 Valves, 9d.

2/-—Tool or Instrument carrying cases, ex Government stock; wood, 9in. x 7in. x 7in.; 2/-

SOUTHERN RADIO, 46, Lisle St., London, W.C.2. Gerard 6653.

RYALLS RADIO, 280, High Holborn, London, W.C.1, offer new goods, post free. ELLIPTICAL Speakers, Celestion, suitable Ekco replacements, 750 ohms, less transformers, speech 25 ohms, new, handle 8 watts, carry up to 120 m.a.; 3/9 each, to clear.

FERRANTI Air Core Type Tuning Coils, transformer wound, can be used as band pass, tuned grid with reaction, chassis type; three for 2/6, with coil connections.

T.M.C. 0.5 mf. Paper Tubular Condensers, N.I., 400v., D.C. working, 3 for 1/3; Erie 60 ohm 1/2-watt resistances, 1/3 dozen; Erie 1,500 2-watt resistances, 4 for 1/3; 600 ohm wire wound, 3 watt, 4 for 1/3.

THIMBLE Top Caps, 24 for 1/3; Cornel Dubilier mica, 0.001, 0.002, 0.003, 1/3 dozen; 9-pin plugs, with cap and socket, 2 for 1/6; Octal top caps, with hood and screened lead, 4 for 1/3; Octal wafer, V.H., 3 for 1/3.

SATOR 5,000 ohm Pots, with switch, 1/3; Sator 10,000 ohm broad base, without switch, 1/3; Centralab 11,000 ohm short spindle, less switch, 2 for 1/3; Epicyclic (reduction) drives, 2 for 1/3.

ELECTROLYTICS.—Plessey or T.C.C. 30x8x2 at 300v. working, 1/6 each, 12/- doz.; 25 mf. x 25v., 2 for 1/6; T.C.C. 8 mf. wet type 802 upright casing, 440v. working, 460v. surge, 1/9 each, 15/9 dozen.

VOLUME Controls.—1/2 meg., with switch, Morganite Stackpole, ex K.B., 1/9 each; Murphy type 1/2 meg., with D.P. switch, 1/9; Sator 1/2 meg., D.P. switch, 1/6.

MAGNAVON 2,000 ohm 8in. speakers, with pen-tode transformer, 7/-; R. & A. 2,500 ohm 8in. speakers, pentode trans., 7/-; Plessey 6,500 ohm speakers, Pentode trans., 6/6.

SPEAKERS.—Pairs elliptical cone M.C. speakers. Plessey and R. & A., ex Philco, push-pull pentode transformer, fields 325 ohm for smoother, 8,600 ohm as bleeder, handle 10-15 watt, 10/9 pair.

GOLDTONE Mains H.F. Chokes, 120 watt, 2 for 2/9; Plessey midget semi screened twin gangs, 2/9; Plessey twin gangs, screened, with trimmers, 2/6

AMERICAN Type 2V Valves (1A, B4, 2101) in A sets three, VM/HF/Pen., HF/Pen., and 1/2 watt output pentode, with valve base circuit and details, 4- and 5-pin, with top grids, 5/9 set three; valve holders, chassis, to suit, 3/9.

AMPLIFIER Kit Parts for 12 watt output, single 6L6 output, V.H., etc., mounted on chassis, 10x7, complete with four valves, pair Celestion elliptical speakers, resistances, condensers, tone and volume controls, and comprehensive circuit, 3 stage high gain, fully tested; 45/6, carriage paid.

BEST Known Make, 1 watt, colour coded carbon resistances, 20 sizes, as ordered; 2/6 dozen; 1/2 watt type, 2/- dozen.

SATOR 1,500v. Test Tubular Condensers, assorted, equal numbers, 0.0002-3.5, 0.001, 0.03, 0.05, 0.002-3, mica; all at 50 for 2/6.

ASSORTED Resistances, 50 for 2/6; 1 watt carbon, U.S.A. make, reasonable assortment given, sizes approx. 450-12,000-17-60-70-90-120 thousand ohms.

TRIMMERS on Porcelain Plessey, double and single, 50 100 200-160 ohm. approx.; 50 for 2/6; special price quantities.

ULTRA Type Brown Knobs, octangle, plain arrow, U.L.S., 1/9 dozen, 8/6 gross assorted, 10/6 gross plain or arrow.

SMALL Iron Core Coils, made by Varley, aerial and oscillator, 465 k/c, 2/6 pair, with coil connections for straight type gang.

FERRANTI Wire Wound 2 1/2 watt Resistances, with metal end caps, tubular, sizes 3,000, 4,000, 6,000, 8,000, 35,000; four for 1/3.

CLIX Valve Holders, 4- and 5- and 7-pin, square and oblong, 1/3 dozen; chassis types, 4- and 5- and 7-pin, round type, with cover, 2/6 dozen.

REX Type Switches, 4B, 2P, 4w., with shorting plates on 5 switches, 2/6; 4B, 2P, 3w., 1/6; 3B, 4P, 3w., 1/3; screens, 3 1/2 x 3 1/2, 5 for 1/3.

PLESSEY 3-gang Fully Screened Straight Type Condensers, with top trimmers, 2/9; Plessey 3-gang straight type, all wave, ceramic insulators with SM cord drive, fitted antimicro feet, 2/9. [8906]

COMPONENTS—SECOND-HAND  
CLEARANCE, SURPLUS, ETC.

**R.**  
**RADIO CLEARANCE, Ltd.,**  
63, High Holborn, W.C.1. Phone: Holborn 4631.  
**A**MAZING Offer.

**5**-VALVE A.C. All-wave Superhet Chassis; latest Mullard valves: T.H.4B, V.P.4B, T.D.D.4, Pen. A.4 L.W. 4-350v.; ranges: Short wave 16-48 metres, med. wave 200-560 metres, long wave 800-2,200 metres; size of chassis, 14½in. long, 7½in. deep, height overall 8½in., control tuning at side, volume on/off at side, wave change, provision for pick-up; complete with valves and knobs, £4/17/6; special speaker, 1,500 ohms field, 10/6.

**RICE-KELLOGG** Senior 12in. Moving Coil Speakers, 20 watts, 1,000 ohms, 11 ohms speech coil; with-out speech transformer 32/6 each, with transformer tapped 3,000 ohms and 7,000 ohms, 35/- each.

**GRAMPION** 10in. 10-watt 2,500 ohms Energised Speaker, heavy cast frame, 15/- each; with heavy duty pentode speech transformer, 17/6; heavy duty speech transformers, pentode matching, 2/11 each.

**PLESSEY** 2-gang Straight Condensers, 1/6 each; ditto, 3-gang, 2/- each.

**ROLA P.M.** Speakers, latest type 7½in. cone with pentode transformer, boxed; 14/6 each.

**CLOCK Faced Dials**, 5in. x 3½in., with printed 3-wave scale, ox-copper escutcheons and glass; 3/6 each; ditto, less escutcheons; 2/6 each; horizontal dials, with plain scale, 7½in. x 3½in., and pointer, 1/- each.

**PLESSEY** Mains Transformers, 350-0-350v., 90 m.a., 4v. 2.5 amps., 4v. 6 amps.; 8/6 each.

**FILAMENT** Transformers, input 200-250 volts, output 4v. 4 amps., 4v. 6 amps.; 4/11 each.

**G.E.C.** Mains Transformers, American windings, 350-0-350v., 65 m.a., 5 volts 2 amps., 6.3 volts 2.5 amps., suitable for replacements in G.E.C. models; 5/6 each.

**WEARITE** Mains Transformers.—Type R.C.1, 250 0-250v., 80m.a., 4v. 2.5 amps., 4v. 4 amps., 9/11 each; type R.C.2, 350-0-350v., 120 m.a., 4v. 2.5 amps., 4v. 4 amps., 12/6 each; type R.C.3, 350-0-350v., 150 m.a., 4v. 2.5 amps., 4v. 2 amps., 15/- each; type R.C.4, 500-0-500v., 150 m.a., 4v. 2 amps., 4v. 2 amps., 4v. 2.5 amps., 4v. 5.6 amps., 21/- each; type R.C.5, 100-watt auto transformer, 100-110v.-200-250v. reversible; 12/6 each; type R.C.6, 350-0-350v., 80 m.a., 5v. 2 amps., 6.3v. 5 amps., 6/11 each.

**CHASSIS** Mounting Valve-holders, American 4, 5, 6, and 7-pin, 4d. each; octals, 6d. each; octals, 10d. each; 7-pin English type, 3d. each.

**POLAR N.S.F.** 1-watt Resistances, 4d. each, 3/9 dozen; all sizes up to 2 meg.; Wearite 110 k.Ω I.F. transformers, -1/- each.

**AMERICAN C.T.S.** Volume Controls, finest made, divided spindles, length 2½in. with switch, 2,000, 5,000, 10,000, 25,000, 100,000, 250,000, 500,000 and 1 meg., 2/6 each; wire wound 5-watt (less switch), 2,000, 5,000, 10,000, 20,000 and 25,000 ohms, 2/- each; 24 mfd. can type electrolytics, 450 volts working, 1/- each.

**B.I.** Wire End Type Bias Electrolytics; 50 mfd. 12 volts, 1/6 each; 50 mfd. 50 volts, 2/- each; tubular wire-end non-inductive paper, all sizes up to 0.1, 5d. each, 4/9 dozen.

**PLESSEY** Energised Speakers, 6in. cone, 2,500 and 1,500 ohms field; 5/11 each.

**BATTERY** Output Pentodes, well known make; 3/11 each.

**BATTERY** Double Diode Triode, well known make; 3/6 each.

**ROTARY** Converters, 6 and 12 volt, D.C. input, output 240v. 40 m.a.; state voltage when ordering; to clear, 15/- each.

**RAYTHEON** First Grade Valves, largest stockists, all types in stock, including glass series, glass octal series, metal series, bantam series, single-ended metal series, and resistance tubes, all at most competitive prices; send for valve lists.

**ALL** Orders Must Include Sufficient Postage to Cover.

**HOURS** of Business: 9 a.m.-6 p.m. week-days; Saturdays 9 a.m.-1 p.m.

**PLEASE** Write Your Address in Block Letters.

**RADIO CLEARANCE, Ltd.,** 63, High Holborn, London, W.C.1. Phone: Holborn 4631. [8933

**MAINS RADIO DEVELOPMENT COMPANY'S** Super Service; immediate delivery; carriage paid or C.O.D. Telephone: Tudor 4046. Stamp for list 234.

**T.C.C.** Card Case Electrolytics, 600v. surge, 8 mfd., 2/-; 8x8 mfd., 3/6.

**B.I.C.** Metal Can Dry Electrolytics: 550v. 8 mfd., 2/9; card, 8x4 mfd., 525v., 2/9; 50 mfd. 50v., 1/9.

**N.S.F.** Unused, marked and colour coded resistors, ½ and 1 watt, ten useful sizes in each parcel of 20 resistors for 1/- only.

**TUBULAR** Condensers, unused, wire ends, best make, 400v. working, 0.0001 to 0.1 mfd., 5d.; 0.25 to 0.5 mfd., 8d.

**CLIX** Unused Chassis Valve Holders, English, 5-pin, 7-pin, 4d.; all American sizes, 6d.

(This advt. continued in 3rd column.)

COMPONENTS—SECOND-HAND  
CLEARANCE, SURPLUS, ETC.

(This advt. continued from 1st column.)

**CENTRALAB** Unused Latest Potentiometers, long standard spindle, all sizes, 2/3; with switch, 2/6.

**DUBILIER** Unused Mica Condensers, midjet tags, 0.0005 to 0.0005 mfd., 3d. each, 2/6 dozen.

**ERIE** Unused One-watt Resistors, all sizes, 4d. each, 3/6 dozen; two-watt, 7d.

**MAINS RADIO DEVELOPMENT COMPANY,** 52a, Church Crescent, Muswell Hill, London, N.10. Tudor 4046. [8905

**COLPHONE** RADIO, Grimshaw Lane, Ormskirk. —Collaro A.C. gramophone motor, 12in. turntable, 27/6; with pick-up, 42/6; Rola G12 speakers, energised, 52/6; P.M. 65/-; portables, midjets, valves. All brand new goods. 1/4d. stamp list. [8896

Wanted

**COLVERN** "Colpak" ("H"/G-3) Tuning Unit, or similar, offers.—5, Uppingham Rd., Wallasey. [8932

**WANTED,** Telefunken T.D.1001 pick-up, good condition; price about £3/10.—Trier, Woodlands, Kingston Hill, Surrey. [8894

MISCELLANEOUS

**CARDS,** memos, billheads; 1,000, 5/9; samples.—"B", Tices, 11, Oaklands Grove, London W.12. [8893

**EVERY** Radio Dealer Who is Not a Regular Reader send his trade card at once for a specimen copy and full details of the "Trader" Services. The Wireless and Electrical Trader has the widest influence, the largest weekly circulation, and is read by all the leading manufacturers and traders. Trade only. 15/- per annum, post free. Published at Dorset House, Stamford St., London, S.E.1. [0615

REPAIRS AND SERVICE

**LOUD-SPEAKER** Repairs, British, American, any make, 24 hours' service; moderate prices.—Sinclair Speakers, Pulteney Terrace, Copenhagen St., N.1. [8936

**GUARANTEED** Repairs, any transformers, choke, motor armature, converter, dynamo, etc.; keenest prices, immediate quotation, prompt, dependable service.—See below.

**L.T.P. (LONDON TRANSFORMER PRODUCTS, Ltd.),** Willesden, N.W.10. Willesden 6486 (3 lines). [6892

**MAINS** Transformer Service, repairs, rewinds, or construction to specification of any type, competitive prices and prompt service.—Sturdy Electric Co., Dipton, Newcastle-on-Tyne. [0516

**"SERVICE with a Smile."**—Repairers of all types of British and American receivers; coil rewinds; American valves, spares, line cords.—F.R.I., Ltd., 22, Howland St., W.1. Museum 5675. [8934

**METROPOLITAN RADIO SERVICE.**—Guaranteed repairs to American and British receivers; American valves, service parts and rewinds; trade supplied.—1021, Finchley Rd., N.W.1. Speedwell 3000. [0435

**EPOCH** Speaker Service, genuine replacement diaphragms for all models, 99s. Domino, Super-cinema, etc., precision rewinding.—"R.E.C.S." Crown St., Reading. Phone: 2796. Trade enquiries invited. [8888

**REPAIRS** to Moving Coil Speakers; cones/coils fitted or rewound; fields altered or wound; prices quoted, including eliminators; pick-ups and speaker transformers rewound, 4/6; trade invited; guaranteed satisfaction; prompt service.—L. S. Repair Works, 5, Balham Grove, London, S.W.12. Battersea 1321. [0394

**CHALLENGER** RADIO CORPORATION.—Repairers of British and American receivers to the trade; lowest prices with good workmanship; "service with a guarantee"; also speakers, transformers, coils, etc., rewound.—Challenger Radio Corporation, 51, Craven Terrace, Lancaster Gate, London, W.2. Paddington 6492. [8788

SITUATIONS VACANT

**AIR** MINISTRY.—Civilian Wireless Instructors Required.

**VACANCIES** Exist for Civilian Wireless Instructors at the Electrical and Wireless Schools, Royal Air Force. The commencing rate of pay is £4/5 a week, inclusive, which may be increased to £4/10 a week after a short period of satisfactory service. Candidates must be capable of lecturing and must have a sound knowledge of electrical principles and their application to radio and low-power electrical engineering. Applications should be addressed to the Under-Secretary of State (S.5.d.), Air Ministry, Kingsway, W.C.2, giving particulars as to previous experience, age, &c. Suitable candidates will be required to appear before a Selection Board at the School for interview and trade test, but may be reimbursed the cost of third class travelling expenses for this purpose. The test will include the giving of a lecture on any subject which may be chosen by the candidate involving the principles of modern radio. Lecturing sequence and style are most important. [0616



**M'CARTHY**  
The Chassis Specialists

THREE NEW RECEIVERS

available in Chassis form  
or complete in Cabinet  
for those who desire

Individuality and Reliability

R.S. 640 - - - £9. 17. 6

P.P. 840 - - - £12. 12. 0

P.P. 940 - - - £15. 15. 0

Cabinets - - - from £1.10.6

Matched Speakers from £1. 5.0

Write for Illustrated Brochure giving  
full details and specifications

**H. M'CARTHY LTD.** (C. H. S. Smith, Receiver and Manager)  
Wyndham Works, Oldham Terrace, Acton, W.3  
Phone: ACOrn 4639



**SPADES**  
For Every Purpose

- Small, No. 414 ... 11d.
- Large, No. 415 ... 2d.
- Heavy Wiring, No. 416 ... 3d.
- Keyhole, No. 418 ... 2d.
- Hook, No. 419 ... 2d.

Usual colours and engravings

**CLIX**

British Mechanical Productions Ltd  
1, Church Road, Leatherhead, Surrey

**WARD** WE MANUFACTURE:

- ROTARY CONVERTERS
- DC/AC for operating P.A. amplifiers, Radio Receivers, etc.
- DC/DC ROTARY TRANSFORMERS, SMALL ALTERNATORS, SMALL DC MOTORS, H.T. GENERATORS, MAINS TRANSFORMERS up to 10 k.v.a. PETROL ELECTRIC generator sets up to 50 k.v.a.
- BATTERY CHARGERS for private and industrial use.

We can also handle general small engineering work.  
Full details of any of the above upon request

**CHAS. F. WARD**  
46, FARRINGTON ST., LONDON, E.C.4  
Telephone: Holborn 9703.  
Works: Bow, E.



# B.I. COPPER EARTHING RODS

for WIRELESS APPARATUS

(U.K. Patent Nos. 438598, 423385, 430040.)



**100% MORE SURFACE AREA**

Designed to give a low resistance earth contact. Made from solid drawn H.C. copper. The multiple fins ensure larger surface area and better contact with the earth than any driving earth of similar diameter and weight at present on the market; giving nearly 50 per cent. more contact area than a circular rod of equal diameter, or 100 per cent. more than a solid rod of equal weight. About 1 1/2" of the rod is left exposed and the earth lead is simply clamped against the rod by means of the copper clamp ring and screw. No sweating or soldering is required. Supplied in two standard sizes, 18" and 24". Longer rods of similar type can be supplied, if desired, to meet special requirements.



**BRITISH INSULATED CABLES LTD.,**  
CABLE MAKERS AND ELECTRICAL ENGINEERS,  
PRESCOT, LANCS. Tel. No. PRESCOT 6571

# McMURDO SILVER RADIO



The receiver with a sensitivity of one microvolt absolute  
*May we send you details*

**THE ERSKINE LABORATORIES LTD.**  
PROSPECT WORKS NORTH STREET  
SCALBY, SCARBOROUGH

## POST THIS COUPON NOW



The possession of this book is more imperative than ever to discriminating constructors. It describes the world's most reliable rectifier—Westinghouse—in detail; contains many practical circuits; and a wealth of information on H.T. supply, battery charging, detection and A.V.C., etc.

The Westinghouse Metal Rectifier needs no replacement and is very economical and efficient in use.

**WESTINGHOUSE BRAKE & SIGNAL CO. LTD.,**  
Pew Hill House, Chippenham, Wilts.

*I enclose 3d. in stamps. Please send me a copy of "THE ALL-METAL WAY."*

Name.....  
Address.....

W.W. 440

## LISTENERS EVERYWHERE!

Why miss the very items you particularly wanted to hear? With Extension Speakers installed in all the main rooms of your house you can hear the best of the programmes wherever you are. Critical enthusiasts are employing STENTORIANS because they appreciate how well economy of price has been combined with quality of reproduction. Your dealer will be pleased to demonstrate—Prices range from 19/3 for Chassis Models and 21/6 for Cabinet Models, and leaflets describing the full range will be gladly sent on application.



# Stentorian

THE PERFECT EXTRA SPEAKER FOR ANY SET

WHITELEY ELECTRICAL RADIO CO., Ltd., MANSFIELD, NOTTS.



**T**HERE'S a wealth of significance for Radio designers in the old saying "Trifles make perfection." Take T.C.C. Ceramic Condensers for instance. Perhaps the smallest components in a radio chassis — but certainly some of its most important. For the ceramic condenser plays a vital part in *maintaining* the efficiency of a Receiver. T.C.C. Ceramic Condensers are made to exceptionally low tolerances — their electrical losses are small — they are non-inductive — their insulation resistance is high — they are almost indestructible and unaffected by humidity changes and they are available with either positive or negative temperature coefficient to choice. Further, according to capacity requirements, they are available in Discs, Cups and Tubes.

## **T.C.C. CERAMIC CONDENSERS**

THE TELEGRAPH CONDENSER CO. LTD., WALES FARM ROAD, NORTH ACTON, LONDON, W.3.